



**PRODUCT
OVERVIEW**



Heat exchanger's world

MAUS ITALIA SPA IS THE WORLD LEADING MANUFACTURER OF TOOLS AND MACHINES FOR THE PRODUCTION AND MAINTENANCE OF HEAT EXCHANGERS



A winning story since 1961

The Beginning

Domenico Franco Agostino was born in Messina in 1917. Aged only 14, he decided to seek his fortune in the North, his destination being Milan. Aged 28, after serving throughout his youth for seven long years during World War II, he began his career determined to achieve his dream of setting up his own business. During the war years, Franco met by correspondence Luisa Capoferri, a girl from Crema soon to become Mrs Agostino, who would be one of the pillars of the future business.

His business card read: 'Franco Agostino Industrial Dealer'. The two made contact with manufacturers of welding machines, abrasives, thermometers and pressure gauges, an industry Franco was familiar with thanks to his apprenticeship in Milan. In 1959, by pure coincidence Franco became the Italian representative of Albert Otto, a German manufacturer of tube expanders.

In 1960, Albert Otto's owners - elderly and childless - put forth to the Agostino family to manufacture the German product directly in Italy: in 1961 Franco Agostino's Albert Otto Italiana was founded and in 1972, after purchasing an area of 10,000 square metres in the municipality of Bagnolo Cremasco, Maus Italia Sas was established.

The Growth

In 1976 his son Stefano, a mechanical engineer, joined the company. Together with his father, he studied products, introduced new machinery onto the market and filed the first patents by Maus Italia.

Stefano proceeded with determination: he believed in technological innovation and market diversification achieved through a widespread sales organisation allowing the brand 'Maus Italia' to expand all over the world.

Above all, Stefano was firmly convinced that people are the very heart of a company's success. Therefore, he invested in human capital by valuing people and roles, and he surrounded himself with skilled operators as well as technical, commercial and administrative collaborators. The result was a winning, competent and proactive team.

His daughter Anna - also a mechanical engineer - has been working in the company since 2016, giving new impetus and energy to the business her father and grandfather had built.

Father and daughter work together side by side every day to guarantee the excellence of Maus Italia and support all customers worldwide with competence and passion: the company's distinctive traits.

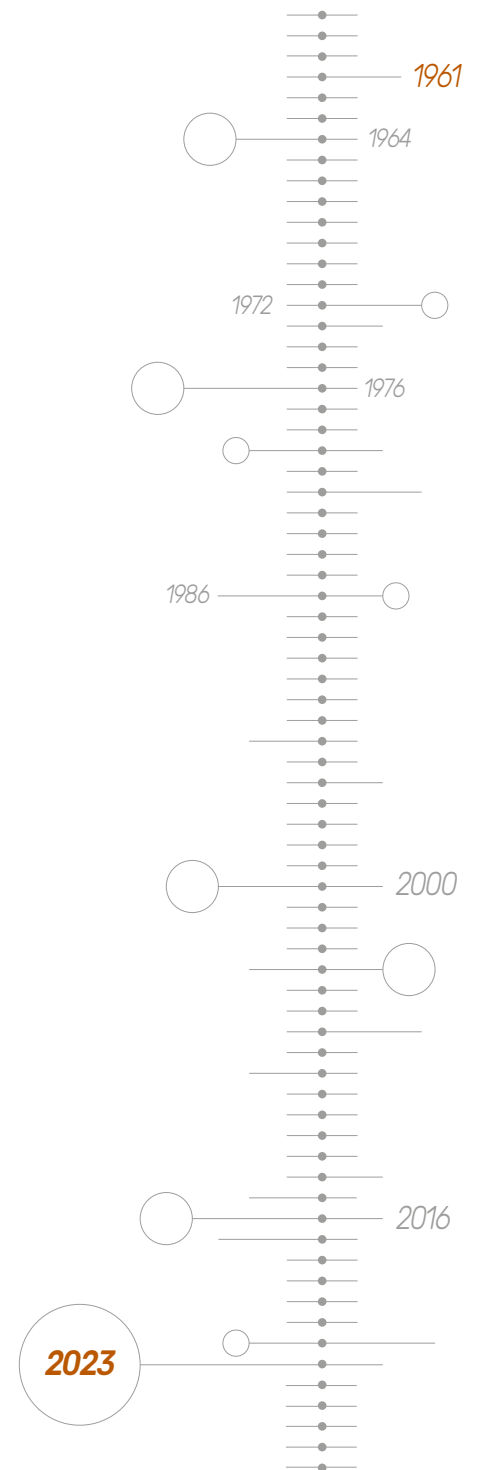

Stefano Agostino

CEO - Mechanical Engineer

Anna Agostino

COO - Mechanical and Management Engineer

A close team

Leading the industry worldwide

Maus Italia relies on a team of 63 staff who devote themselves daily to the design and production of Maus' products with care and competence. Rigorous procedures, commitment to R&D and passion for working with an innovative, sustainable and flexible approach ensure the highest quality in products and services.

Experience, quality and continuous innovation make Maus Italia the number one company in its sector Europe-wide and place it at the top of the world rankings. Such achievement is also the result of the commitment and synergy of the entire company staff: teamwork is one of the keys to Maus Italia's success.

Headquarters on **35000** sqm



Every day in over

80

country worldwide

Our extensive sales network guarantees full availability and satisfies even the most demanding customers. In its over 60 years up and running, Maus Italia has built an efficient business organisation and a dense international sales network, with agents and distributors in more than 80 countries all over the world.

Find an official distributor
in your country





In-house production of each component **Workshop 4.0 and 24/7 production control**

The production of Maus Italia branded items is entirely carried out in Bagnolo Cremasco, in the heart of an Italian industrial area 30 km southeast of Milan.

The company boasts a 4.0 workshop equipped with state-of-the-art machinery, an in-house heat treatment room and a final inspection department that allow Maus Italia to independently manage every phase of the manufacturing process of its wide range of products whilst maintaining high quality standards.

Quality first. Design and development

One of Maus Italia's strengths is its willingness to understand its customers' needs.

Our technical department is always ready to find operational solutions to the most complex applications, even via feasibility studies. We develop accurate work processes, draw with FEM analyses to verify our mechanical-structural performance and optimise the manufacturing process of each component.



Ready To Deliver. Optimisation and efficiency

A well-stocked and complete warehouse of finished products enables Maus Italia ship quickly to customers all over the world according to a ready-to-deliver logic.

The warehouse is fully located within our premises in Bagnolo Cremasco at controlled temperatures and conditions to guarantee the maximum safety and quality of Maus Italia products for all our customers.

Quality, environment and safety policy

Research, quality and safety are the watchwords of Maus Italia Spa.

Maus Italia has several projects underway aimed at increasingly sustainable development and integrates environmental concerns into its business model. The company's actions, behaviour and development choices are focused not only on the short run but rather mainly on a medium and long-term horizon.



Index

pag

Automation

Flaring the holes of the heat exchangers baffles - <i>Baffletech Twin 2000</i>	12
Automatic CNC tube rolling work centre - <i>MA 400</i>	14
Single axis CNC working centre for rolling and facing - <i>MA 500</i>	16
CNC working centre for rolling, facing, grooving and TIG orbital welding - <i>MA 2501</i>	18
Automatic CNC positioning tube to tubesheet TIG orbital welding system - <i>Matig 502</i>	20

Tube rolling

Pneumatic rolling machines - <i>Minirol / Fastrol / Macrol / Masterol / Fastron</i>	24
Portable electric system for tube expansion - <i>Portrol 401</i>	26
Mobile semi-automatic system for tube expansion - <i>Quadrol 90x</i>	28
Mobile semi-automatic hi-tech system for tube expansion - <i>Matex</i>	30
Hydraulic tube rolling equipment for the expansion of boiler tubes - <i>Hydrol</i>	32
Ultra high pressure water hydraulic system for tube expansion - <i>Hydrex</i>	34

Tube expanders

Series for heat exchangers - <i>R Series</i>	38
Series for heat exchangers - <i>MG Series</i>	39
Series for boiler tubes - <i>BH / CH / DH / F602</i>	40
Series for cracking furnaces - <i>F500</i>	41
Series for sugar plant - <i>VP100 / SG100</i>	41
Series for milk industry - <i>DIN / BS</i>	42
Series & Special models - <i>VN / DN</i>	42

Accessories

<i>A comprehensive range of internal gauges, tools and accessories designed for the manufacture of tubesheet heat exchangers</i>	46
--	----

TIG orbital welding

Portable hydraulic tool for tube locking (tack expansion) - <i>Kattex Fix</i>	54
Tube to tubesheet TIG orbital welding system - <i>Giotto Basic</i>	56
Advanced tube to tube-sheet TIG orbital welding system - <i>Giotto FullControl</i>	58
Automatic CNC positioning tube to tubesheet TIG orbital welding system - <i>Matig 502</i>	60

Tube bundle insertion for workshop use

Tube bundle inserter for heat exchangers - <i>BundleIN XT60</i>	64
Tube bundle inserter and extractor for heat exchangers - <i>Mef shopIN</i>	66

Tube bundle extraction and handling

Aerial extractor for heat exchanger tube bundles - <i>Mef Express HT</i>	70
Aerial transporter of the tube bundles - <i>Bundle Tutor Lifter</i>	72
Trasporter for the handling of the tube bundles - <i>Bundle Tutor Mobil</i>	74
Tube bundle puller for the extraction and transportation of tube bundles - <i>Mef Mobil</i>	76
Tube bundle puller to be mounted on the truck - <i>Mef TT 23</i>	78
Fixed tube bundle puller for the extraction of tube bundles - <i>Mef Fixed NAVY</i>	79

Tube cleaning

Mechanical internal cleaning with rigid shafts for heat exchanger tubes - <i>Hardscal</i>	81
--	----

Tube & tube bundle cutting

Band saw for the dismantling of tube bundle - <i>BundleCut Evolution</i>	84
Hydraulically operated internal single tube cutter - <i>Kattex Cut</i>	86
Motor operated internal single tube cutter - <i>F/794</i>	88

Stub & tube extraction

Quick gripping and extracting hydraulic stub puller - <i>Grippul</i>	92
Automatic hydraulic tube pulling for high speed extraction of tubes - <i>Runpul</i>	94
Semi-automated hydraulic tube puller for small-scale maintenance - <i>Onlypul</i>	96

Manual tools

Equipment for the manual maintenance - <i>F/790 - F/791 - F/792 - F/793 - F/789</i>	98
--	----

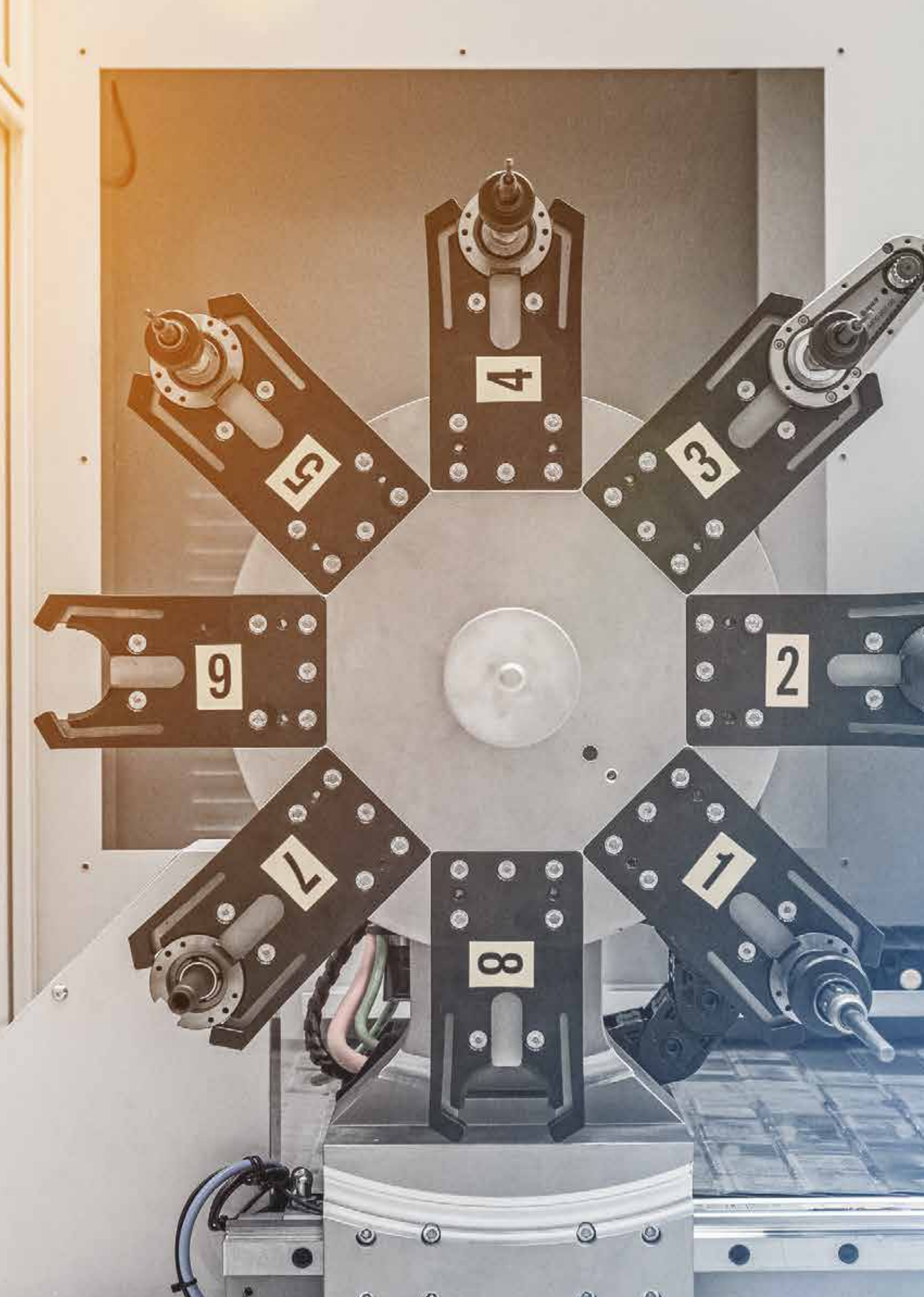



Automation

CNC working centres and special machines for manufacture tube bundle heat exchangers

In this section, Maus Italia gives a comprehensive overview of its unique CNC working centres and special machines to clearly illustrate the innovative path that a modern heat exchanger manufacturer should take to solve the basic issues of productivity, quality and safety without delay.

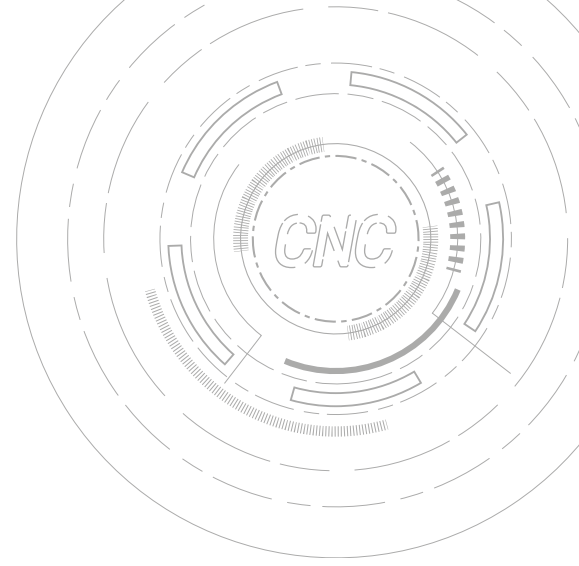

Baffletech twin 2000

Automatic centre with double head for flaring the holes of the heat exchangers baffle up to O.D. 2000 mm (78")

The Baffletech twin 2000, entirely designed and manufactured by Maus Italia, allows the simultaneous flare of the holes on both sides of the baffle in a single pass without the need for additional operations thanks to two opposing heads which are equipped with self-centring tools.

The Baffletech twin 2000 also permits:

- a uniform depth flare thanks to the special design of the tilting head
- precise centering of the flare in relation to the axis of the hole due to the innovative self-centring mandrel tool-holder
- programming of the work sequence using dedicated software developed by Maus Italia

The Baffletech twin 2000, is equipped with CNC control for:

- the movement of the baffle
- the independent positioning of the two heads
- the movement and independent rotation of the tools

Up to O.D. 2000 mm (78")

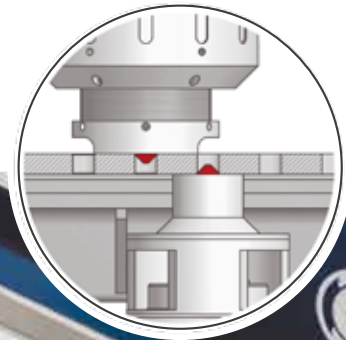



Baffles loading & unloading

CNC-controlled movement of the baffle with a quick connecting system and centring system with zero workpiece.

Work heads

Two opposing heads, located above and below the work surface, ensure high productivity without the need to turn the baffle.



Rake system

Mounted on two mechanical arms, this is the innovative solution offered by Maus Italia for the quick hooking of the baffle for ensuring the zero workpiece and permitting the movement of the baffle.



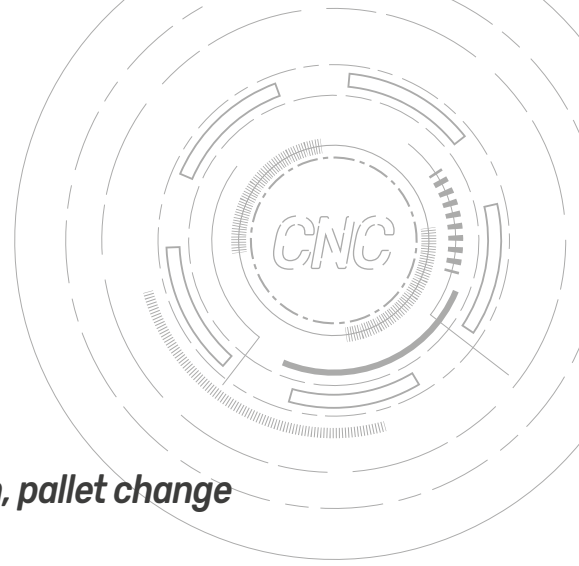

MA 400

Automatic CNC tube rolling work centre with machine vision, pallet change and fully automatic changing tools device

Maus Italia has solved the problem of production of small dimension tube bundle batches with an automatic tube rolling working centre complete with innovative solutions, such as:

- machine vision system for rapid centring of holes;
- multiple fixing templates with vertical loading for the assembly of tube bundles and precise positioning for production;
- pallets for the loading / unloading of tube bundle batches in front of the MA 400.

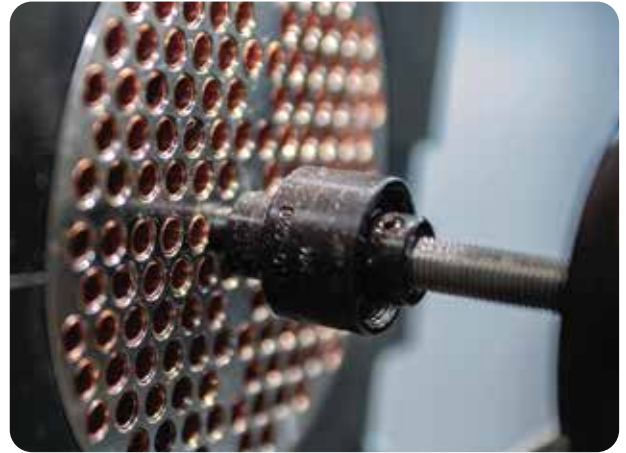

Quality, uniformity and repeatability of the tube-tubesheet joint guaranteed

**More than 600 tubes/hour
1 cycle in less than 6 sec.**

CNC control console

Located to ensure maximum visibility of the working zone, it is extremely user-friendly and ensures maximum operational simplicity and access to all parameters by the operator.





MausCAMNET

Interface software for X-Y programming

Created by MAUS ITALIA technical staff to facilitate the expansion of work cycles, it allows the automatic processing of a CAD design of the tubesheet hole pattern



FOCS3

Self-learning electropneumatic centring probe

Used in large Maus Italia work centres, it performs all centring and correction of the distance from the tubesheet using a laser measuring system.



NEW FEATURES

Automatic tool change system

- Possibility to perform various processes in sequence without manually intervening on the machine
- Possibility of mounting several identical tools and managing the life of each tool automatically
- Possibility to perform different rolling steps by assembling tube expanders with different rolling depth

MA 500

*Single axis CNC working centre for rolling and facing
ideal for serial production*

The MA 500 is the most innovative and effective solution ever offered by Maus Italia for automating the process cycles of small heat exchanger assembly for high volume production.

- High technology
- Maximum productivity

**600 tubes/hour
1 cycle every 6 sec.**

**Tubesheet max diameter
1000 mm (40")**

**Tubesheet max thickness
200 mm (8")**

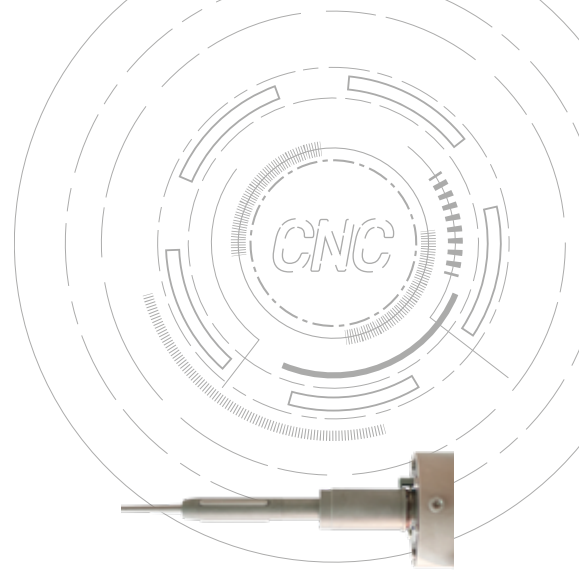

Total quality

Long lasting reliability



Free tube

Rolling on a tube simply inserted into the tube sheet - without being blocked and consequently free to move longitudinally - has been one of the first issues successfully solved by the Maus Italia MA series machines.

Automatic compensation of the expansion limit depth

The external edge of the tube sheet becomes the reference mark for each single tube, regardless of the tubesheet deformation or the machine alignment to the tube sheet.

Mandrel forward movement digital control

The mandrel forward movement digital control enables to verify the real-time actual tube expansion dimension. This technology enables to record the value of any performed expansion.

Speed continuous variation

The latest innovation in rolling. The tube expander mandrel rotation speed varies continuously according to the instantaneous torque.

Pendulum process with trolleys

Continuous positioning in front of the machine eliminates load / unload downtimes, thus increasing production.

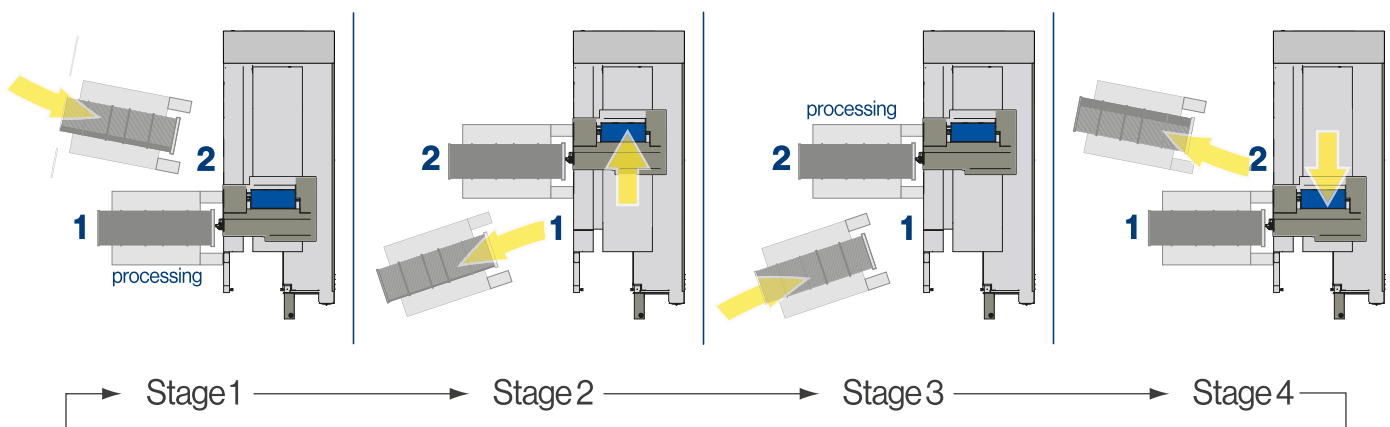

MA 2501 - MA 3501

*Single or double axis CNC working centre
with movable machine for rolling, facing, grooving
and TIG orbital welding*

The MA 2501 is the most innovative and effective solution ever offered by Maus Italia as an automatic process for the construction of medium and large sized heat exchangers.

- High technology
- Maximum manoeuvrability

Up to 850 expansions/hr
Up to 1200 faces/hr
Up to 800 grooves/hr

Tubesheet max diameter
3500 mm (140")

Tubesheet max thickness
700 mm (27.5")

Maximum productivity

The MA-2501 CNC working centre enables the single or double axis expansion, TIG orbital welding, and facing of the tube sheet tubes as well as the optional grooving of the tube sheet holes: entirely automated and cost efficient processes and a remarkably reduced production time.

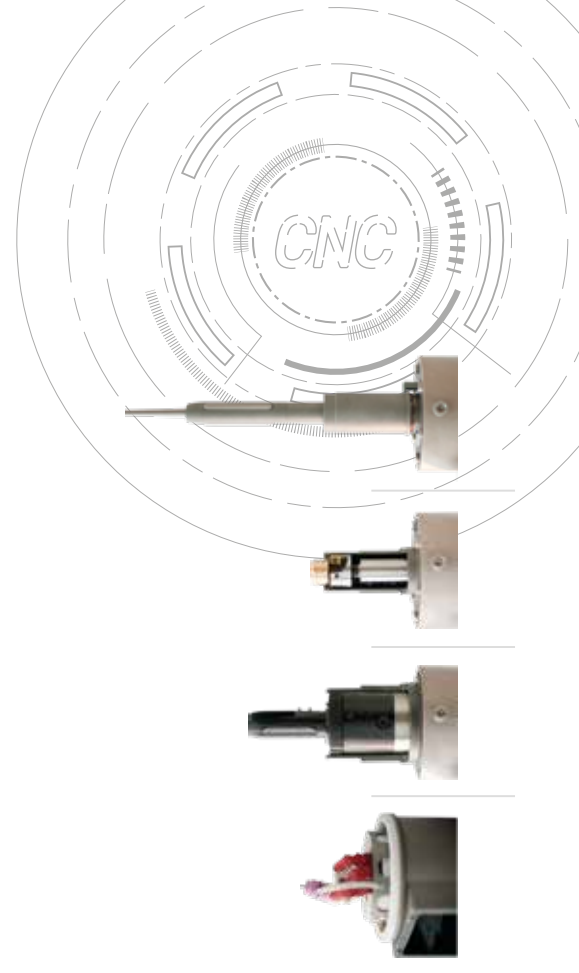

Total quality

Long lasting reliability



Free tube

Rolling on a tube simply inserted into the tube sheet - without being blocked and consequently free to move longitudinally - has been one of the first issues successfully solved by the Maus Italia MA series machines.

Automatic compensation of the expansion limit depth

The external edge of the tube sheet becomes the reference mark for each single tube, regardless of the tubesheet deformation or the machine alignment to the tube sheet.

Mandrel forward movement digital control

The mandrel forward movement digital control enables to verify the real-time actual tube expansion dimension. This technology enables to record the value of any performed expansion.

Speed continuous variation

The latest innovation in rolling. The tube expander mandrel rotation speed varies continuously according to the instantaneous torque.



FOCS3

The unique FOCS3 centering system is a self-learning electropneumatic device for automatic tubes centering and correction. This device is controlled by software exclusively designed by Maus Italia.



Detection and display of the distance to the tubesheet using a class 1 laser device (centering precision to 0,05 mm / 0,002"). Rapid detection of work piece zero, calculation and storage of the grid location of the holes in the tube sheet. Measurement is performed by a class 1 laser system.

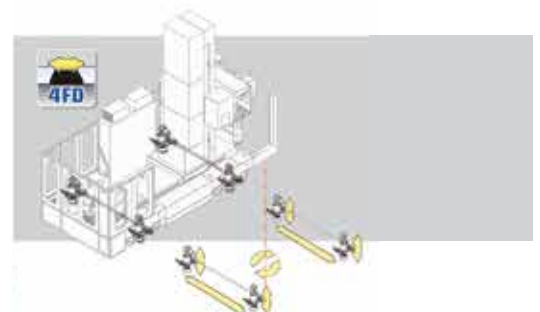

SERVO HYDRAULIC BASE

The new MA2501 servo hydraulic machine base guarantees durability and precision. In particular, the 4 positioning stabilizers help to compensate for horizontal positioning errors. The transmission system on each stabilizer guarantees continuity and precision in movement.

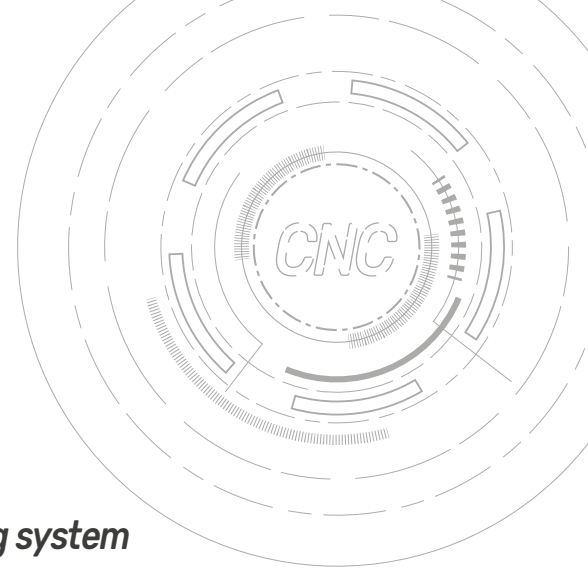

Matig 502

Automatic positioning tube to tubesheet TIG orbital welding system

Maus Italia presents the evolution of its TIG orbital welding working centre with new functional, ergonomic and aesthetic solutions, in response to practical requests from its increasingly demanding customer base.

With its Giotto 250 Auto welding head, graphic interface, MausCAM software and many other components of the highest quality, a milestone has been reached in the quality control of the tube-tubesheet welded joint.

➤ for tubes from 1/4" to 2" (from 6,35 to 50,80 mm)

High speed

Fully automatic

High productivity

High precision



Laser centring probe FOCS3

Self-learning FOCS3 laser centring system which can work in sync with the CNC as well as independently.

Unique self-learning electro-pneumatic centring system guaranteeing precision of the geometries of the welded joints managed by dedicated Maus Italia software.

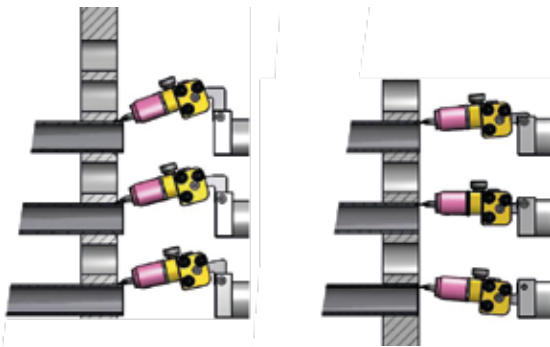
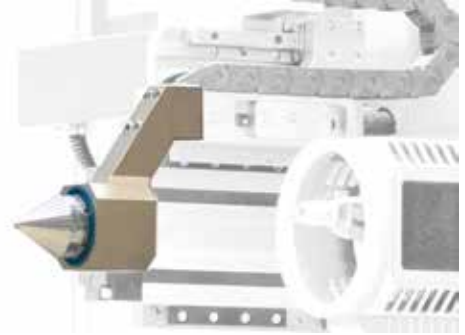

Electrode angle of incidence

Thanks to components with preset angles, the system setting is absolute and repeatable for all welding geometries.

Facilitates geometric set up operations as well as being extremely stable and robust.



New orbital TIG welding torch

The only product of its kind. The new orbital TIG welding torch has been designed and manufactured in its entirety by Maus Italia. The new electrode clamping system with tangent screws does not require service keys and makes replacing the worn electrode quick (it is no longer necessary to dismantle the ceramic nozzle, the relevant gas diffuser and the filler wire guide).

The wire feed assembly is fully adjustable in all directions. All operations are carried out with a single supplied key.



MausCAM^{NET}

Conversion software for X-Y programming starting from CAD drawing used for tubesheet holes drilling

DXF from CAD standard

The system is based upon the reading of the DXF drawing interchange format and is able, in a few steps, to process the CAD files of the tube sheet and automatically obtain the matrix of the coordinates of the tubesheet holes.

Interactive processing

During processing it is possible to control and optimise the path according to the position or the geometry. If the tube sheet is larger than the usable stroke, it is possible to divide the program into several successive parts.

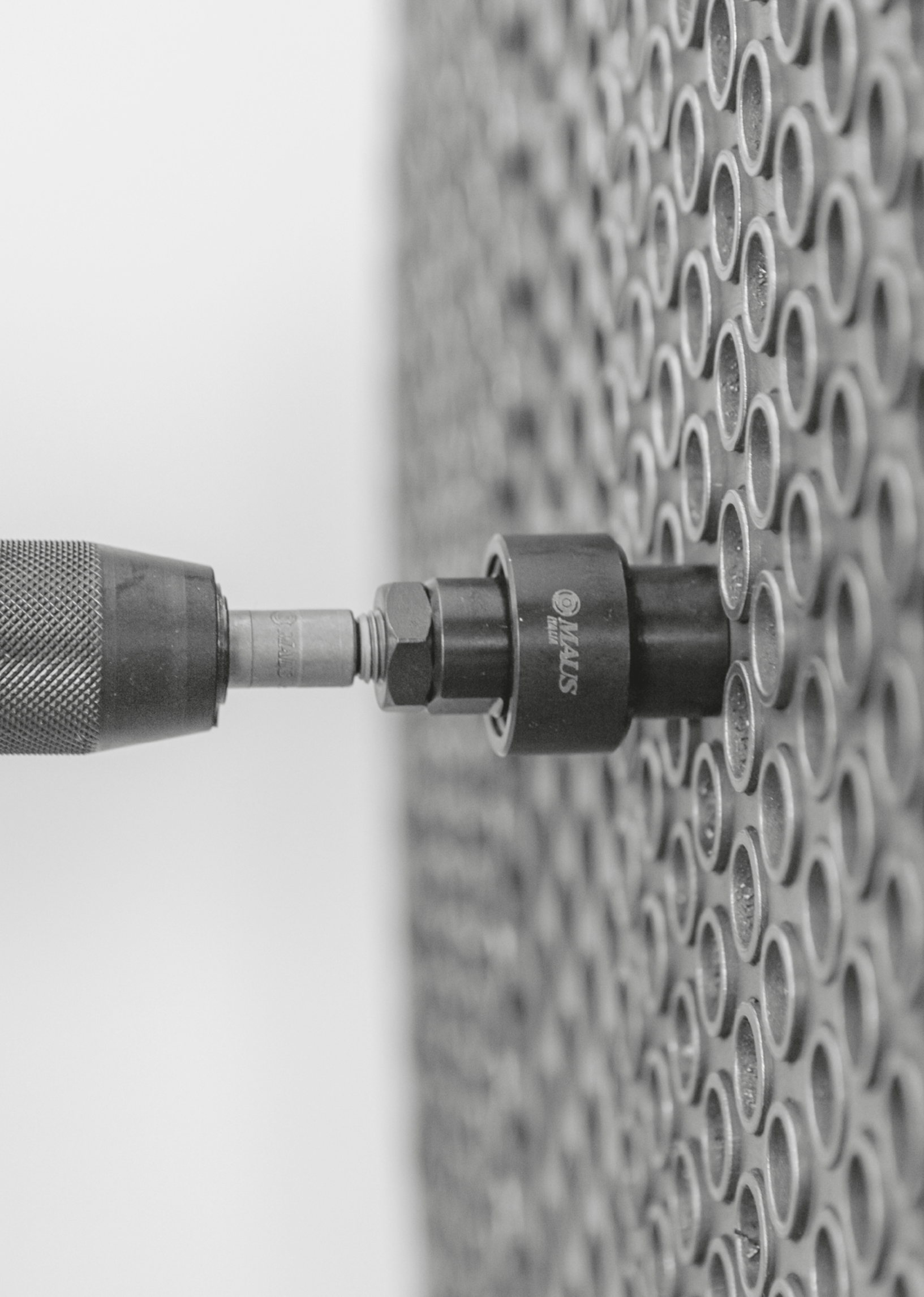

Tube rolling

Tube rolling (or expansion) in the production and maintenance of tube bundle heat exchangers

Maus Italia is a world leader in the production of tube expanders. Tube rolling is a mechanical operation that allows the tightening of one element to another by means of a mechanical deformation known as expansion. This is achieved by means of a tube expander, a tool which allows the deformable section of the element to be enlarged without prejudicing its mechanical integrity.

Pneumatic rolling machines

Torque control pneumatic rolling machines

Maus Italia pneumatic rolling machines are quick, light and safe, and are the idea solution for heat exchanger manufacturers and maintenance operators who want to operate on-site in a safe enviroment and with high quality equipment.



Minirol

Air conditioner and air cooler assembly

Torque control pneumatic rolling machine with automatic reverse from 1/4" to 1/2" (6.3 to 12.7 mm) tubes

Up to 1/2" (12,7 mm)



Fastrol

PUSH PULL

Heat exchanger on-site maintenance

Pneumatic torque-controlled tube rolling system for tube diameters from 3/4" to 1.1/4" (19,0 mm to 31,8 mm)

Up to 1.1/4" (31,8 mm)



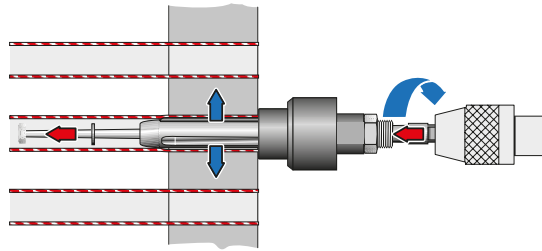
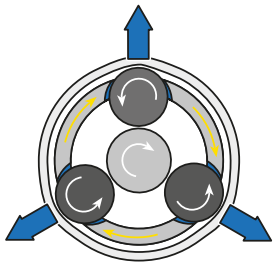

By its **Minirol**, **Fastrol**, **Macrol** and **Masterol** series, Maus Italia offers a flexible and cost-efficient solution to use tube expanders. The Maus Italia pneumatic rolling machines are swift, light, and safe and they are the ideal solution for both manufacturers who are equipping themselves to expand tubes for the first time and maintenance operators who want to operate on-site in a safe and high quality environment.



Macrol

Heat exchanger on-site maintenance

Wide range of torque control pneumatic rolling machines suitable from 3/4" to 2.1/4" (19,0 to 58,0 mm) tubes

Up to 2.1/4" (58 mm)



Masterol

Boiler assembly

Right angle torque control pneumatic rolling machines suitable for boiler tubes up to 4" (101,6 mm)

Up to 4" (101,6 mm)



Portrol 401

Portable electric controller Port 401 with 400 Volt three-phases PR-1000 motor for controlled tube expansion

A good compromise between quality and price. Specially designed for quality maintenance operations or for small heat exchanger batch production. Maus Italia has designed and manufactured the first fully portable three-phase 400 Volt expansion machine which, meet strict European standards.

- Expansion torque selection
- Automatic motor rotation stop when selected torque is reached
- Multi-function display
- Manual rotation reversal
- Remote controlled
- No-load rolling motor resetting

High quality

Long life

Reliable and robust

Repeatability $\pm 5\%$



➤ Lightweight: only 13 Kg (28 Lb)





For quality work where maximum portability is required

Easy to move with its own wheeled case, the Portrol 401 and the 400 Volt three-phases PR 1000 tube roller ensure a fast system setup and short time for working parameter programming via its display interface.

Three-phases 400 V system

Portable

Low price

Easy to handle

PR 1000

Portable three-phases electric tube rolling machine

Designed to be used in combination with the Port 401 electronic controller. Thanks to its external PVC casing, as well as being extremely robust, it also complies with strict insulation standards.

Proposed for the rolling of tubes, it can also be used for cutting and end-facing tubes.

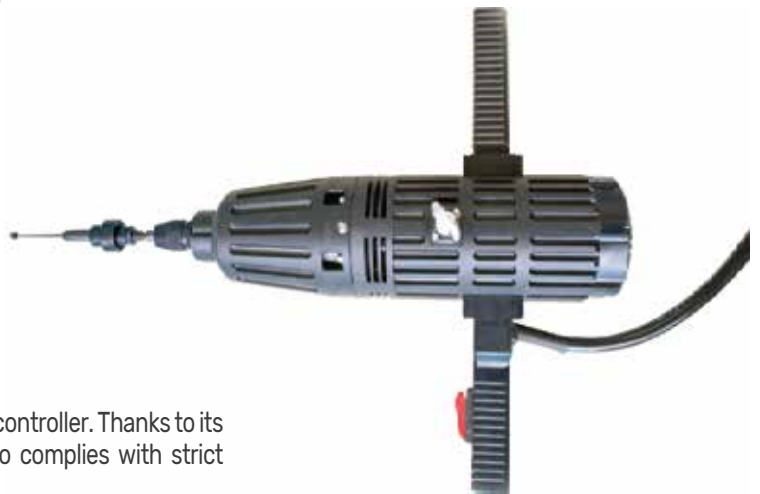

Port 401

Portable electronic controller for the rolling of tubes

Designed to be used in conjunction with PR 1000 series rolling motors it is compact and lightweight

➤ User friendly



Quadrol 90x

Mobile semi-automatic expansion stations comprising F90V5x electronic expansion controller and MK low-voltage, three-phases electrical rolling motors

Always at the forefront in research, Maus Italia has designed and produced, thanks to its more than 50 years' experience in the field, its new Quadrol 90x electric mobile station which, with its innovative solutions, allow you to tube rolling on an industrial scale which is characterized by high repeatability.



➤ Standard version

Cheap, lightweight and easy to disassemble.

➤ Plus version

Continuous manual motion along the Y axis
Reduction of the positioning time.

➤ Executive version

Servo driven motion with increased productivity
High reduction of the positioning time.
Cabinets for safe tools and accessories storage.



F90 V5x

Electronic tube expansion controller with microprocessor

The F90 V5x electronic controller is the latest model in the F90 series which, since 1972 have sold in thousands of units all over the world.

Easy to use, the F90 V5x has a dedicated interface and it's protected by a robust metal casing; the controller contains a microprocessor and all controls are managed from a specially designed panel with high brightness display.

- Entering of all programmable values
- Zero setting
- Management of the reverse phase without touching the power supply cable
- Automatic operation selection

MK Series

Low-voltage electric rolling machine with self-ventilating three-phases motor with torque-based speed variation

The MK800 and MK400 are our two models of electrical rolling motors that meet the main technical requirements of the market, according to tube size and required expansion characteristics. With a self-ventilating low-voltage three-phases motor and integrated suspension, the MK Series electrical rolling motor have been specially designed to guarantee robustness, continuous performance, speed variation according to torque and flexible use.

Flexibility of use

With their mechanical 4-speed gearbox, the MK Series of rolling motors are able to optimize the speed range according to the parameters of the job.



MK 800

Up to 1.1/2" (38,10 mm)

MK 400

Up to 2.1/2" (63,50 mm)



Matex

Hi-tech, low voltage electrical mobile stations with R brushless motors and torque-based speed continuous variation for semi-automatic controlled tube expansion

Portable equipment and hi-tech electric mobile stations for semi-automatic controlled rolling of tubes from 1/4" up to 3" (from 6,35 up to 76,20 mm).

Always at the forefront of research, Maus Italia has designed and manufactured, thanks to experience acquired over more than fifty years in the field, their new Matex mobile high-tech electric mobile stations for semi-automatic tube rolling. Top of the range in this category, its innovative solutions allow it to address tube rolling on an industrial scale.

for tubes from 1/4" up to 3" (from 6,35 up to 76,20mm)



FlexMatex

Work station with flexible shaft

Up to 3/8" (9,52 mm)

PortMatex

Work station with portable electric tube rolling system

Up to 3/4" (19,05 mm)

QuadrolMatex

Work station with telescopic shaft

Up to 3" (76,20 mm)



Matex tsx-blu electronic controller

Continuous torque-based speed variation

The Matex tsx-blu electronic tube expansion controller is the brains of the system. Learning to use it is immediate and simple with its 8" LCD touch screen and dedicated software. It is protected by a robust metal casing with IP 55 protection.

The Matex tsx-blu allows automatic tolerance compensation of the diameter of the tubesheet holes as well as the thickness of the tubes, giving a secure and uniform seal of all the tubes decreasing drastically the expansion time and the wear of the tooling.



- Motor absorption (amps)
- Torque delivered to the tube expander (Nm)
- Motor absorption Graph (amps)
- Cycle duration time
- Rotational speed of tube expander
- Successfully completed rolling cycle counter

Electric tube rolling motors series

Robust and silent with a low-voltage (48V) variable speed brushless motor and integrated suspension



USB Memory stick

for the saving of expansion data: program setting and torque value reports



Hydrol

Hydraulic tube rolling equipment for the expansion of boiler tubes

Compared to traditional tube rolling systems, the Hydrol Series hydraulic tube rolling system is able to satisfy the demands for handling and power typically required for working inside the cylindrical bodies of water tube boilers.

Nevertheless, the high technological level of the control system and its remarkable robustness mean that its application could be extended to all sectors.

The Hydrol system is particularly recommended for the rolling of tubes up to 8" (220 mm)

Tube up to 8" (220 mm)

Special tube rolling systems for boiler and cracking furnace tubes



Hydrol 40.2

The Hydrol 40.2 is the professional hydraulic rolling system model designed for continuous use typical of industrial production.

The Hydrol 40.2 stands out for its extraordinary capacity to use two independent portable tube rolling heads simultaneously, ensuring a high-quality tube expansion.

The Hydrol 40.2 control and power unit allows you to work simultaneously with two rolling heads which are independent of each other, driven by two independent thermostabilised hydraulic circuits.

This machine is recommended for repetitive jobs and where precision, power and speed are required.



Continuous cycle digital controller

The exceptional quality of the torque control ensure automatic compensation of any differences in the diameters of the tubesheet holes as well as the diameter and thicknesses of the tubes.

The result is a uniform seal for all the boiler's tubes at working pressure.



Hydrol 40.1

Professional model with a single hydraulic rolling motor.

Hydrol 20.1

Manually controlled hydraulic unit for tube rolling expansion with a single hydraulic rolling motor.



Hydrex

Ultra high pressure hydraulic system for expanding heat exchangers tubes with minimum inside diameter of 7,00 mm (0.276")

In order to comply with the increasingly stringent specifications coming from the petrochemical, nuclear and chemical fields, Maus Italia has designed and manufactured the **Hydrex 5003**, a fourth generation product which has been acclaimed by our customers for more than 16 years.

The **Hydrex 5003S** is the 'full optional' version of the 5003 series, that Maus Italia has developed for specific application in the nuclear sector or in the "high quality" heat exchanger tube working process, and has the following features:

- The **HF6000** hydraulic gun, used for tack expansion, has been designed for the pre-welding positioning of tubes using a polymer ring to prevent any metal contamination
- The **2TH400** hydraulic anchoring device, essential for the proper positioning of the probe to reduce the effects of crevice corrosion

Up to 5000 Bar (72500 Psi)

Welding preserved

Controlled positioning of the tube without contamination

No crevice corrosion



Control console equipped with a 9" wide touch screen display for an intuitive control of all operating parameters

Thanks to its last generation touch screen control panel, the Hydrex 5003 ensures an extremely simple learning and daily use.



HDP-4001

Probe holder with quick coupling standard supply with Hydrex 5003 with aluminium ergonomic handle and probe shank in special material for ultra high pressure.



PDP

Example of a probe with precise diameter designed to avoid contamination during the expansion process. Designed according to customer specifications.



Tack expansion

Controlled positioning without contamination



2TH-400

Hydraulic anchoring device

Longitudinal position, expansion guaranteed

- Preserves the inner tube sheet from crevice corrosion
- Preserves the welding (external tube sheet)

Reduction of operator effort



HF-6000

Portable hydraulic system (tack expansion) moved by water

- Radial positioning guaranteed
- Integrated remote controller (24V)
- Positioning of the tube without contamination

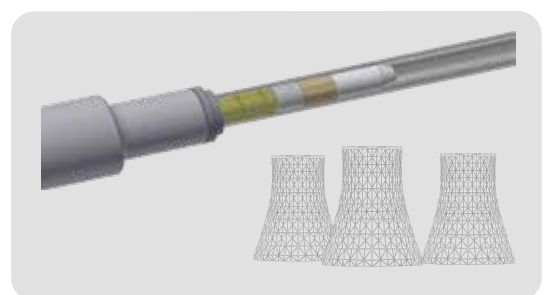

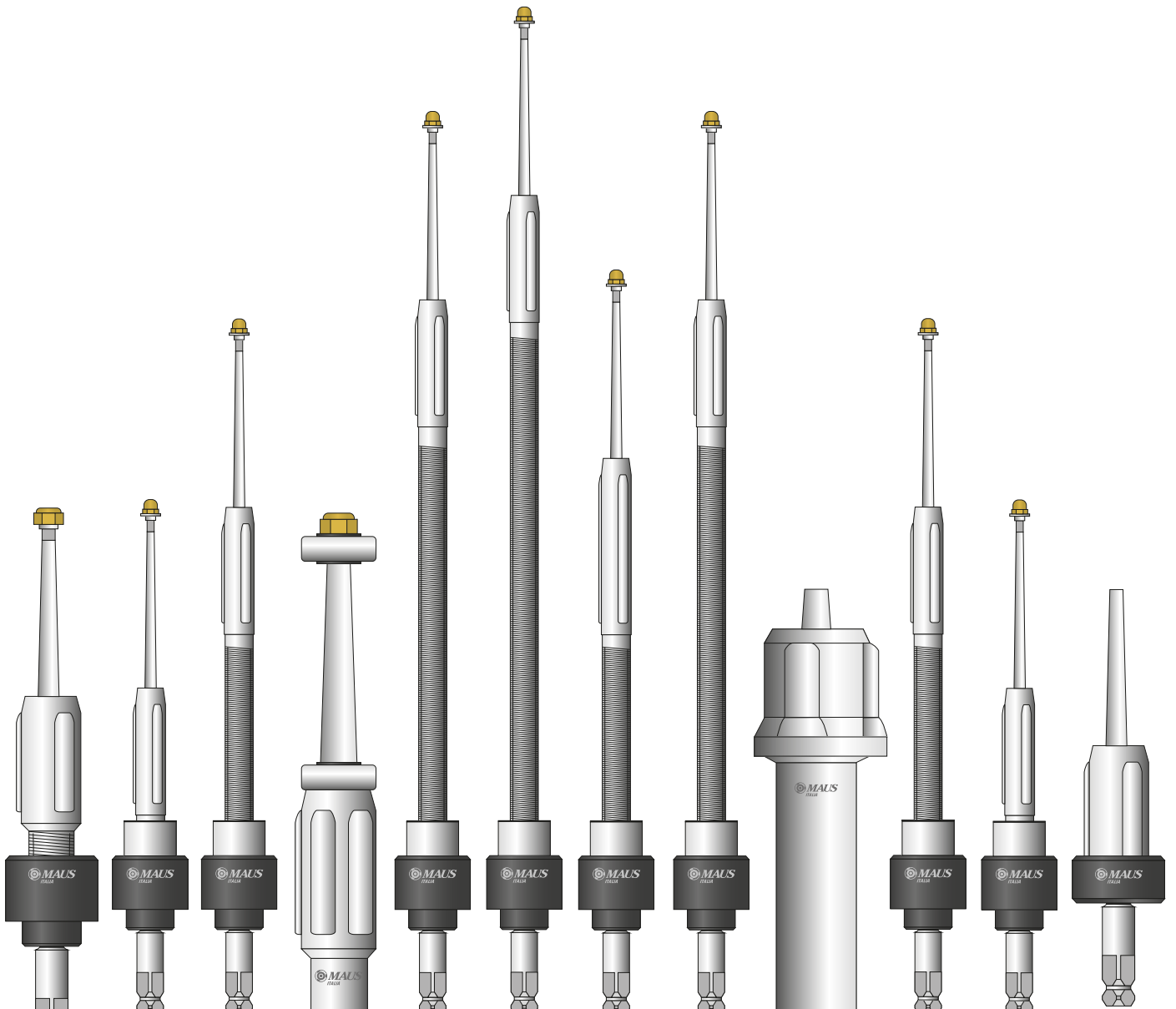

Tube expanders

Maus Italia is a leader in tube expanders production and tube rolling equipments

The tube expander, constructed with heat-treated alloy steels that are resistant to wear and tear, is composed of four main parts: the cage, the mandrel, the rollers and the thrust collar.

The tooling process begins by introducing the tube expander, with its mandrel fully retracted, into the tube until the collar comes into contact with the tubesheet. The mandrel is then brought into contact with the rollers which rotate due to friction and, by coming into contact with the tube, move the mandrel forward. The rollers, expanded by the advance of the mandrel, compress the tube until it comes into contact with the tubesheet hole and reduce its thickness.

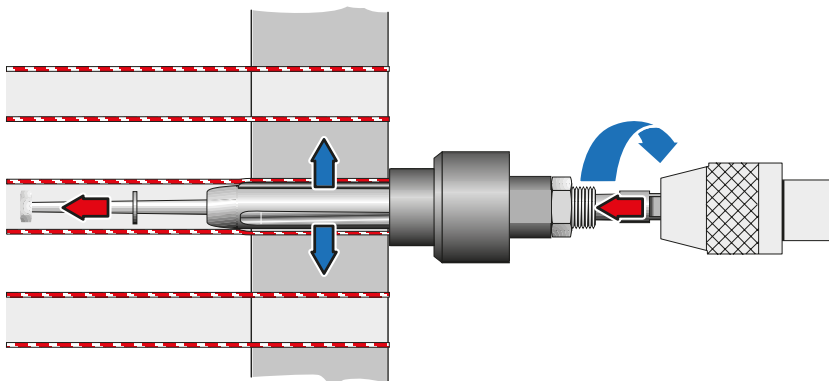

R Series

The R Series, produced exclusively by Maus Italia, stands out for its expansion capacity, reliability and performance

The **R-series** adjustable depth tube expanders have been designed for rolling tubes in heat exchangers and boilers. They can be driven by pneumatic or electric rolling machines with torque control.

The **5R-series** tube expanders have five rolls to overcome the problems of rolling thin-walled tubes, especially those made of titanium. These tube expanders perform special expansions and have gently-tapered mandrels to reduce the problems connected with residual stress in the expanded tubes.

R11 / R13

Tube expanders for tube with small diameters, having a thrust collar with plane shoulder.

➤ From 1/4" to 1/2" (6,35 to 12,70 mm)



R30 / R31

Adjustable tube expanders for thin or medium thickness tubesheets.

➤ From 1/2" up to 1 1/2" (12,70 to 38,10 mm)



R50 / R51

Adjustable long reach tube expanders for thick tubesheets.

➤ From 1/2" to 1 1/2" (12,70 to 38,10 mm)



5R

5R: Code used to indicate type R tube expanders with 5 rolls (instead of standard with 3 rolls), suitable for the rolling expansion of thin thickness tubes to ensure a better roundness on the expanded tube.



R41

Tube expanders for thick tube sheets and tubes with big diameter:

➤ From 1 3/4" to 3" (44,45 to 76,20 mm)



R141 / R161

Step-by-step tube expanders for tubes with Ø from 5/8" to 1" (15,87 to 25,40 mm) with quick release device for thrust collar repositioning to expand the entire tube sheet length without removing the expander from tube.

➤ Step by step positioning thrust collar



MG Series

Complete MG-series (3 rolls) line variable depth tube expanders for tube sheets of low, medium and high thickness for heat exchangers and condenser tubes

The **MG-series** variable depth tube expanders have been designed for rolling tubes in heat exchangers. They can be driven by pneumatic or electric rolling machines with torque control.



MG800 with 1.1/2" short rolls

For **low** thickness tube sheets

➤ OD from 1/2" to 1.1/2" (from 12,7 to 38,1 mm)



MG1200 with 1.1/2" short rolls

For **high** thickness tube sheets

➤ OD from 1/2" to 1.1/2" (from 12,7 to 38,1 mm)



MG800 with 2.1/4" long rolls

For **medium** thickness tube sheets

➤ OD from 5/8" to 1.1/2" (from 15,87 to 38,1 mm)



MG1200 with 2.1/4" long rolls

For **high** thickness tube sheets

➤ OD from 5/8" to 1.1/2" (from 15,87 to 38,1 mm)



Tube expanders for **boiler tubes**

Complete line of fixed depth tube expanders for boiler tubes

The BH CH DH Series fixed depth tube expanders have been designed for rolling boiler tubes.

A development of the B C D Series that Maus Italia has produced and sold with great success for more than 50 years.

All the tube expanders of the BH CH DH Series can be driven by pneumatic, hydraulic and electric rolling machines with torque control.



BH Series

BH Series tube expander with plane shoulder available in the standard version with 3 expansion rolls

➤ *OD from 1.1/2" to 4.1/2" (from 38,10 to 114,30 mm)*



CH Series

CH Series tube expander for rolling and flaring at 15°, available in the standard version with 3 expansion rolls and 3 flaring rolls.

➤ *OD from 1/2" to 4.1/2" (from 12,70 to 114,30 mm)*



DH Series

DH Series tube expander for rolling and flaring at an angle of 15°, available in the standard version with 3 expansion rolls and 3 flaring rolls.

This is the improved version of the CH Series which gives a uniform result in flaring thanks to an adjustable stop.

➤ *OD from 1/2" to 4.1/2" (from 12,70 to 114,30 mm)*



F602 Series

F602 Series tube expander for simultaneous rolling and beading of tubes in boilers.

➤ *OD from 1.1/2" to 3" (from 38,10 to 76,20 mm)*



Tube expanders for **Cracking furnaces**

Complete line of F500 Series tube expanders with adjustable torque clutch, torque control and mandrel feeding device for rolling and flaring thick walled tubes in cracking furnaces tube seats

F500 Series

F500 Series tube expanders with adjustable torque clutch, torque control and mandrel feeding device for tubes up to ASA 8" Sch. 40 (219,10 x 8,18 mm)

➤ OD tubes ASA from 3" to 8" (from 88,90 to 219,10 mm)

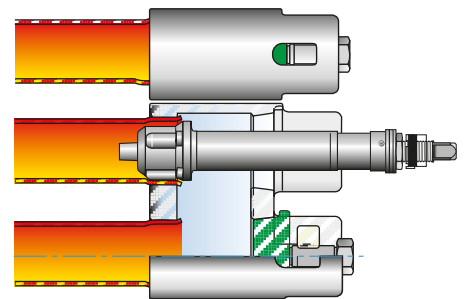

Tube expanders for **sugar production plant**

Complete line of tube expanders for sugar production plant vacuum evaporators

VP100 - SG100

VP100 model for parallel tube sheets
SG100 model for inclined parallel tube sheets

➤ OD tubes up to 4" (101,60 mm)

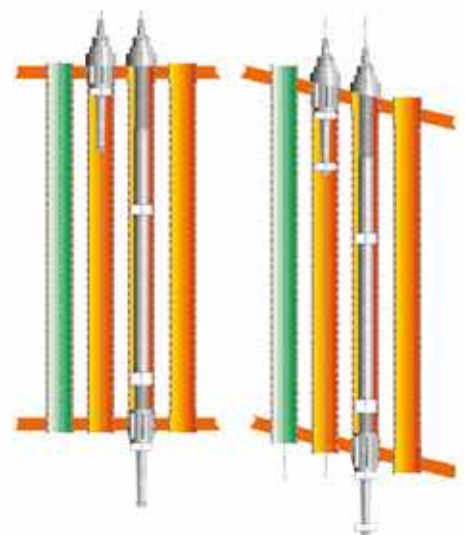

Tube expanders for **milk industry**

Complete line of DIN Series and BS Series (5 rolls) fixed depth tube expanders for the milk industry

DIN Series

➤ OD tubes from 1.102" to 4.094"
(from 28,0 to 104,0 mm)



BS Series

➤ OD tubes from 1" to 4"
(from 25,40 to 101,60 mm)



MTT DIN MTT BS



MSS DIN MSS BS



The system consist of:

DIN Series and **BS Series** tube expanders for stainless steel tubes and bends in accordance with DIN 11851, DIN 11852, British Standard 1864:1966

MTT DIN Series and **MTT BS Series** clamping lugs for cutting tubes

MSS DIN Series and **MSS BS Series** single clamping lugs



Tube expanders for rolling **valve seats**

Complete line of VD Series and DN Series tube expanders for rolling valve seats

VN Series

DN Series

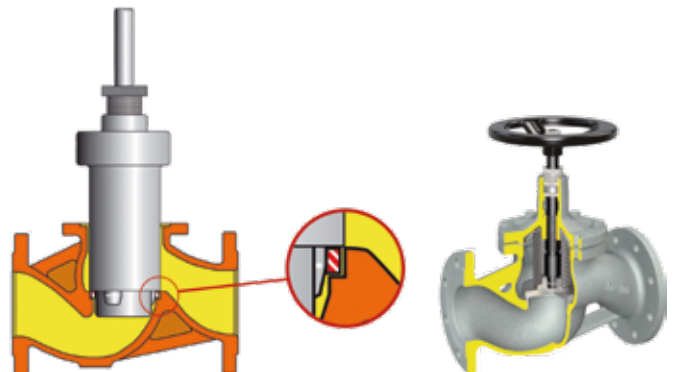







Accessories

A comprehensive range of gauges, tools and accessories designed for the manufacture of tubesheet heat exchangers

Maus Italia offers a wide range of tools and accessories that are essential in a modern workshop, properly equipped for the manufacturing of tube sheet heat exchangers.

Holetest

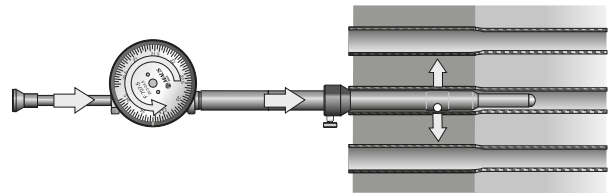

Mechanical and digital instruments for hole measurement

A comprehensive range of mechanical and digital instruments with two and three contact points for measuring tube sheet holes and tube internal diameters, including calibration instruments and relevant accessories.

F/707

Internal mechanical gauge with 3 contact points, designed for the measurement of tube sheet holes and of the tube internal diameter before and after expansion.
(resolution 0,05 mm)



F/700

Internal mechanical gauge with 2 contact points, designed for the measurement of tube sheet holes and of the tube internal diameter before and after expansion. Being particularly lightweight, F/700 is used with a single hand and is dust and splash resistant.
(resolution 0,01 mm)



F/703

Internal digital micrometer with incorporated LCD display and 3 contact points suitable for series testing. Measured data can be recorded and reports can be uploaded as it certifies the work that has been carried out, outputting the measured data report (O of the tube sheet holes and tube inner O before and after expansion).
(resolution 0,001 mm)



Holetool

Tools with coolant fluid feed channels for tubesheet hole processing

The initial stage of the heat exchanger manufacturing cycle is among the most critical ones: the processing and preparation of the tube sheet holes before the assembly.

Maus Italia offers a comprehensive range of tools produced with materials featuring extremely high quality and wear resistance, capable of withstanding high speeds thanks to coaxial drills with coolant fluid feed channel.

Tubes from 3/8" to 2" (9,52 to 50,80)

Coolant distribution

Combined systems consisting of single-size F/12 Maus Italia rotating distributors and F/13 reduction sleeves, available in three sizes, allowing connection to all Holetools for the customer drilling machines which are not equipped with self-lubricant system. It allows the coolant fluid to flow in; as it reaches the cutting point directly from the inside, it guarantees the Hole tools will be long lasting and will always provide high performances.

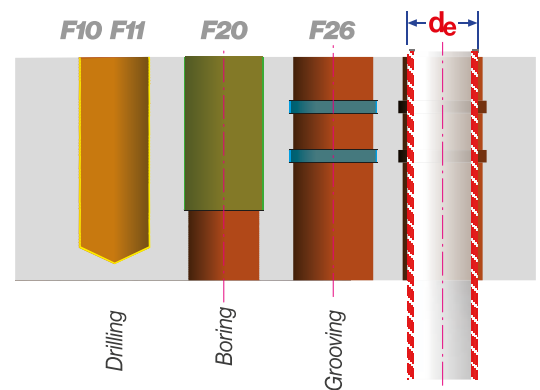

F/12



Rotating coolant distributor for coupling with the F/13 sleeves for use with the Holetool series of tools. Allows the coolant to flow from the inside directly to the cutting point; this guarantees the Holetool series of tools will be durable and high performance.

F/13



Designed and manufactured by Maus Italia, the F/13 series reducing bush is available in 3 sizes to allow connection with the "Holetool" Morse taper.

Drilling

A comprehensive range of twist drills with channels allowing coolant fluid to flow through. They are offered for holes ranging between 9,00 and 50,00 mm (0.354" to 1.969")

F/11



F/10



HSS twist drills with channels to allow flow of coolant fluid

Boring

A comprehensive set of reamers for tube sheet holes with Tungsten Carbide inserts and channels allowing coolant to flow through.

F/20

Reamers with Tungsten carbide tips

A comprehensive set of reamers for tube sheet holes with Tungsten Carbide inserts and channels allowing coolant to flow through. Made using high-quality materials and with ISO h8 tolerance, they are offered with Morse taper. They are manufactured in two modular pieces, to significantly reduce production cost.



Grooving

Supplied equipped with tools designed and manufactured by Maus Italia technical staff members according to customer's specifications. They are suitable to create multiple channels/grooves or to perform multiple special processes at the same time.

F/26

Self-centering grooving tool with adjustable B depth and interchangeable HSS-Co blades

The F/26 self-centering grooving tool creates grooves in tube sheet holes (it is also effectively used for trueing existing grooves) up to a standard depth B that can be adjusted to a value ranging between 1 and 12 mm (0.47" to 0.04"). Greater depths, up to 300 mm (11.81"), can be easily reached using the modular stem, spring and bush kits, while retaining the ability to perform the adjustment mentioned above.



Blades



The F/26 self-centering grooving tools have interchangeable HSS-Co 10% blades in three different sizes for performing multiple tooling operations.

Universal grooving tools

We offer two universal grooving tools without channels for coolant flow through:

F/112

Universal grooving tool, with fixed B depth for tube sheet holes ranging between 7 and 30 mm (0.276" to 1.181")

F/112 is a universal grooving tool, designed and manufactured by Maus Italia using high quality materials, for executing one or more grooves at the same time in tube sheet holes.



F/120

Universal grooving tool with fixed B depth and hydraulic power expansion for holes up to 120 mm (4.724")

F/120, universal equipment with hydraulic power expansion for executing at the same time one or more grooves in tube sheet holes ranging between 15 and 120 mm (0.591" to 4.724"), Seeger ring seats, OR rings, drains, etc.



TubeIN

Tube guide for tube sheet assembly

After preparing the exchanger cage using the manufactured tube sheets and baffles, fastened to each other by means of tie-rods, you can proceed with the actual assembly stage.

Maus Italia offers a comprehensive range of tube guides, aimed at helping and expediting this operation, significantly increasing productivity.

F/780

Tube pilots for tube insertion during tube bundle heat exchanger assembly

It consists of an aluminium conical head (steel, PVC or other materials available upon request) and an interchangeable nylon brush. It aids the quick and smooth insertion of tubes through the tube sheet and baffle holes.

A transverse hole on the conical head allows the easy withdrawal the tube guide, once insertion is completed.

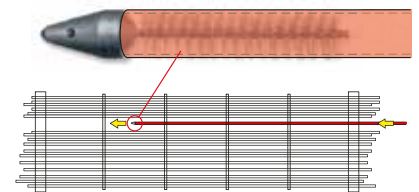

Tubend

Tube facing tools driven by electrical and pneumatic motors

F/796

Motorised tube cutter for cutting the tube protrusion from the tube sheet.
Suitable for tube OD from 1/2" to 1.1/2" (from 12,70 to 38,10 mm)



F/751R

Rotating bell trimming cutter for tube end-facing with HSS cutting tools



F/753

Adjustable combined milling cutter for simultaneous deburring/chamfering of tube outer and inner diameters



Drivenax

Mechanical drive for tube expansion

Maus Italia offers a comprehensive range of shafts and fittings for the mechanical transmission of rotation from motor to mandrel. The brand-new F308HS, the technological evolution of the F308 and boasting new innovative design solutions, is recommended for use at speeds exceeding 400 revolutions/min (r.p.m.) due to its accuracy and stability.

F/308
F/308HS

Telescopic shafts

Telescopic shafts with Cardan joints, the F308HS and F308 series, for the rotation and torque transmission from the rolling motor to the tube expander allowing the horizontal movement required.



The mechanical transmission between the articulated telescopic shaft and mandrel is made by female/female couplings offered by Maus Italia in 3 families:

Quick couplings

The brand new joints with double quick coupling **F/314 HS** and **F/317 HS**, like the traditional **F/313** and **F/316**, facilitate extremely quick tube expander replacement. The new, patented design keeps the input shaft, F/308HS, perfectly balanced and aligned with the tube expander, ensuring vibration levels are well below allowable thresholds.



Fixed joints

The range also includes the fixed joints of the **F/315** and **F/318** series; the latter are used on the F/308-4 telescopic shaft.

Extensions and articulated joints

A full range of extensions and articulated joints are available when working in situations with difficult access conditions.



Ratchet wrenches

The offer finally includes a set of extraordinarily strong reversible ratchet wrenches, specially designed for heavy duty, manual tube expansion.









Tig orbital welding

The complete range of Maus Italia products for tube-tubesheet TIG orbital welding

With the establishment of its "Automation and welding division", Maus Italia aims to bring a complete range of products and services for TIG orbital welding to an increasingly demanding market.

The machines that we design and manufacture are the result of decades of experience with hundreds of customers across the five continents.

TIG orbital welding is the preferred high quality process for tube-tubesheet joints for which high precision technology are essential.

KattexFix



Tack expansion

Fast and accurate

Multiuse portable hydraulic tool for (pre-welding expansion) tube locking in the heat exchangers

Innovative patented system for the instantaneous locking of tubes using a metal expanding plier. The use of the Kattex Fix ensures a precise result in a very limited time thus increasing job productivity.

The Kattex Fix, a Maus Italia patented product, instantly expands tubes in the tube sheet from inside, (controlled mechanical expansion or "tack expansion"), replacing the weld point (tack weld).

- High level of repeatability due the automatic cycle
- **Instant** - Using hydraulic drive, the KattexFix gives the tools an instant radial expansion guaranteeing high productivity.
- **Controlled worked times** - The new dedicated TP2EQ2 hydraulic power unit integrates control of the entire work period
- **Wild range of application** - Thanks to the two different sizes of Kattex, the KattexFix device allows the intervention on pipes up to 4.1/4" (107,95 mm) for the production of industrial boilers

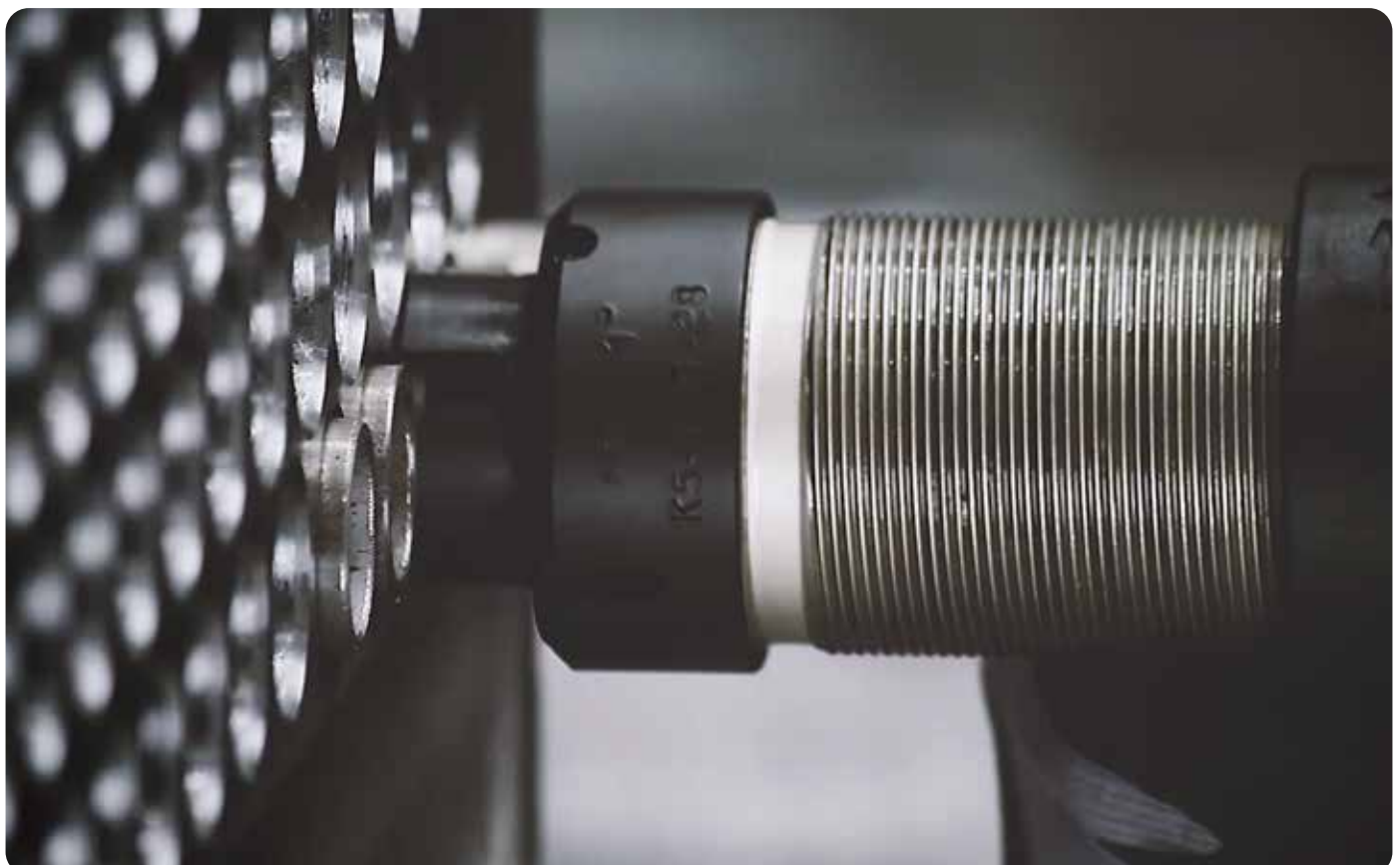



Tack expansion

Due to the expansion of the front plier the tube is mechanically expanded for a few mm, brought to the tube sheet holes and fixed in the required position before the welding operation assuring the perfect alignment between tube axes and tube-sheet hole axes.

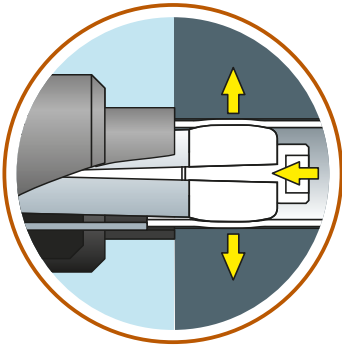

Two versions

KattexFix 6

From 3/8" to 1.1/2"
(9,52 to 38,10 mm)

KattexFix 12

From 1" to 4.1/4"
(25,40 to 107,95 mm)

TP2EQ2

Electric hydraulic power unit with cycle control for KattexFix

An evolution of the TP2E entry level model, the TP2EQ2 has been designed and manufactured by Maus Italia to power KattexFix devices where sensitivity and control in the locking of tubes (tack expansion) is fundamental.

An adjustable timer allows you to set the two expansion control times (T1 expansion+permanence and T2 return time) to guarantee the sure repetition of the " T "work cycle with a significant increase in efficiency.

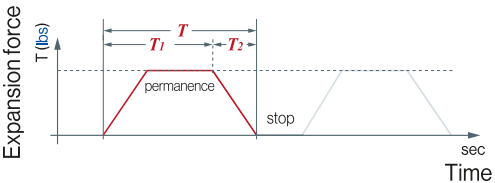

Giotto Basic

Tube to tubesheet TIG orbital welding system for production of tube bundle heat exchangers

Maus Italia presents its new range of Giotto Series orbital heads for tube to tubesheet TIG welding. Following thousands of hours of R&D, tests and prototyping, the result is an outstanding and unprecedented orbital welding head that is a masterpiece developed, manufactured and machined in Italy, with the extreme precision and quality you would expect from Maus Italia.

Giotto Basic is an orbital welding system for tube-tubesheet welding in heat exchangers. Its in-house design and manufacture has enabled us to optimise the design in order to offer a high-quality system, comprising:

- A Giotto 250 B orbital head for tube-tubesheet TIG welding
- Microprocessor inverter generator Giotto Power 200 complete with cooling unit

User friendly

High level quality

Fixed angle - Electrode incidence setting

Adjustable wire feed unit

Single key adjustments

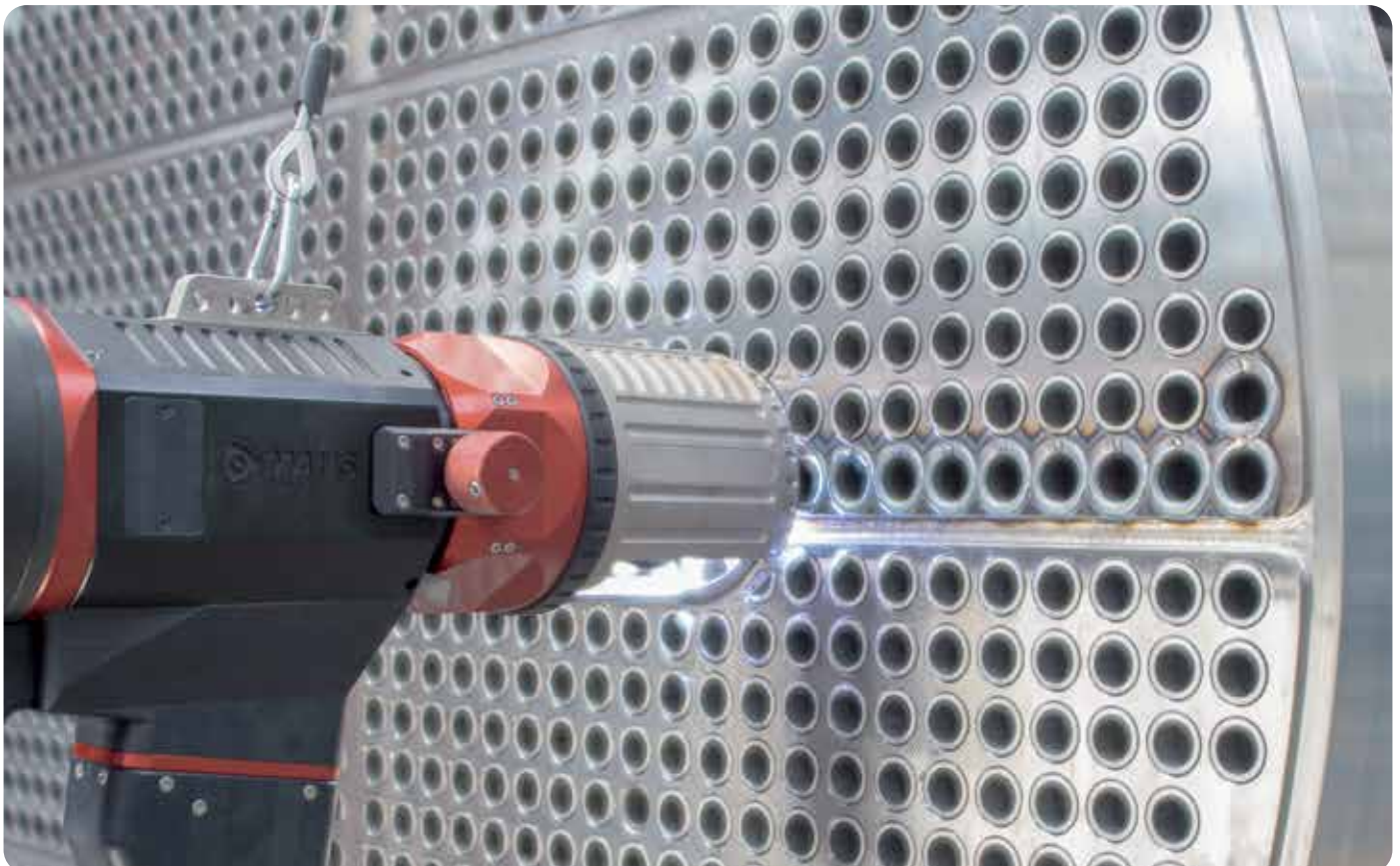

Value for and robust TIG orbital welding complete system

Portable "entry level" product, suitable for simple applications. It stands out for its value for money, ease of use and robustness.

Giotto Power 200-B

Digital inverter generator with integrated control microprocessor and digital display interface.

Lightweight and compact, the Giotto Power 200-B generator is proposed by Maus Italia for controlling the Giotto 250 B TIG orbital welding head.

Mounted on a "carriage pickUp" with a gas bottle holder, the Giotto Power 200 generator is also ideal for onsite service operations.

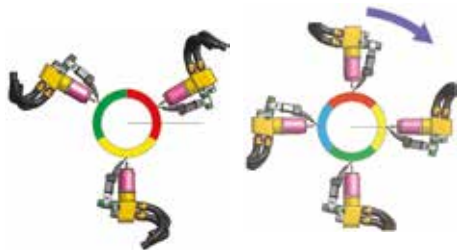

Welding sectors

You can programme, using the integrated software, the subdivision of the weld cycle into up to 4 sectors to compensate for the negative effects of the weight of the weld pool.

For each sector, you can set: breadth in degrees, linear velocity of weld, quantity of filler wire.

Alignment of electrode angle of incidence guaranteed

The Giotto 250 B welding head is the result of a lengthy design and prototyping process. Thanks to the components with preset angles, the system for each welding geometry is absolute and repeatable. Facilitates geometric "setup" operations as well as being extremely stable and robust.

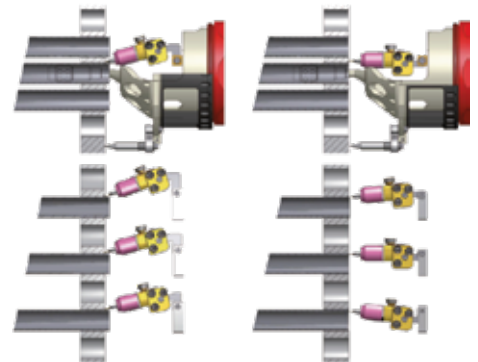

Trust collar system

Different WTC thrust collar systems to be selected on the based of tube geometry and material, with MAUS ITALIA BlockOut screens for anti-dazzle protection.



Cooling

Welding with the ideal temperature
Significant improvement in welding performance

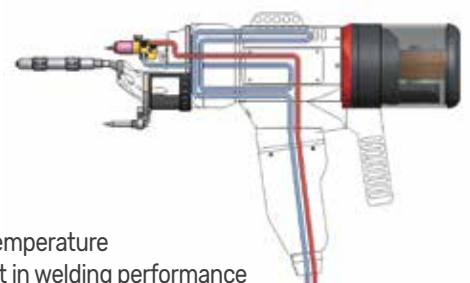

Giotto FullControl

Advanced system for a total control of tube-tube-sheet TIG orbital welding

Maus Italia presents the **Giotto FullControl system**, top-of-the-range trolley-mounted semi-automatic systems for heat exchanger tube-tube-sheet orbital welding. In-house design and construction has allowed this product to be optimised, providing a high quality system, composed by:

- A Giotto FC-250 orbital head for tube-tubesheet TIG welding
- Giotto PG-300-FC programmer/generator with microprocessor inverter complete with cooling unit and touchscreen interface
- Accessories, options and spare parts to meet every need for welding tubes to the tube-sheet

Extremely precise

Revolutionary features

Fixed angle - Electrode incidence setting

Adjustable wire feed unit

Single key adjustments

Continuous recording of the weld

Remote control with display

Protective gas line



Giotto Power 300

Digital programmer/generator with inverter with integrated-control microprocessor and digital interface on monitor

Powerful and compact, Maus Italia's offers the Giotto PG-300-FC programmer/generator for controlling the TIG Giotto FC-250 orbital welding head to guarantee 100% repeatability.

Mounted on "carriage pickUp" with gas bottle holder.



Argo clamp revolutionary technology

Argo clamp instantly expands inside the tube to be welded, locking the orbital head. The Argo clamp is powered by the same protective gas dedicated to the torch electrode.

Argo clamp new technology release is available on our advanced tube-to-tube-sheet TIG orbital welding system Giotto Full Control.

Head locking

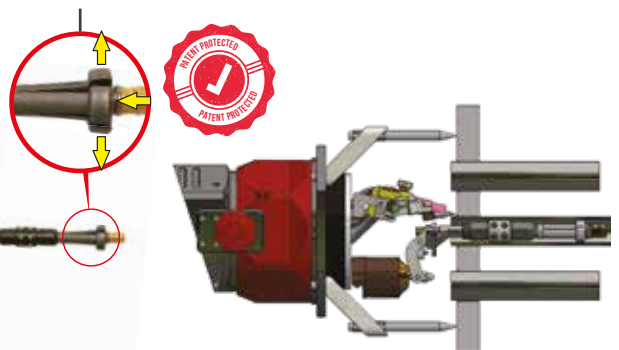

Sliding horizontal trolley-mounted deck for welding head support using balancer



Service trolley and storage for spare parts



Balanced potential power supply for the simultaneous use of two welding systems



TIG orbital welding

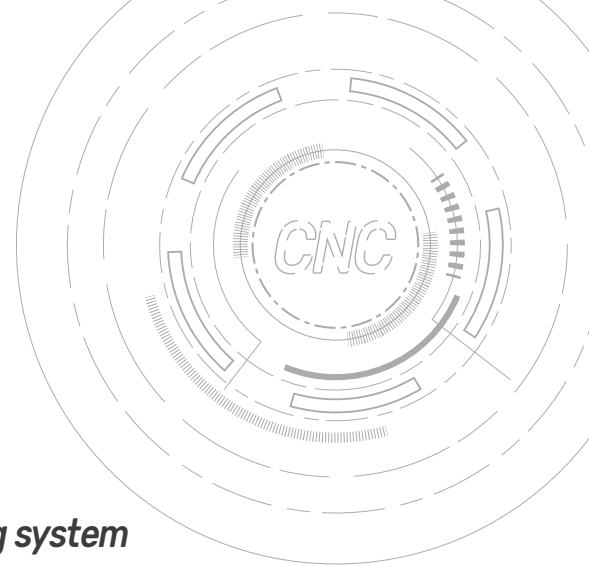

Matig 502

Automatic positioning tube to tubesheet TIG orbital welding system

Maus Italia presents the evolution of its TIG orbital welding work centre with new functional, ergonomic and aesthetic solutions, in response to practical requests from its increasingly demanding customer base.

With its Giotto 250 Auto welding head, graphic interface, MausCAM software and many other components of the highest quality, a milestone has been reached in the quality control of the tube-tubesheet welded joint.

➤ for tubes from 1/4" to 2" (from 6,35 to 50,80 mm)

High speed

Fully automatic

Extreme cost reduction

High precision



Laser centring device FOCS3

Self-learning FOCS3 laser centring system which can work in sync with the CNC as well as independently.

Unique self-learning electro-pneumatic centring system guaranteeing precision of the geometries of the welded joints managed by dedicated Maus Italia software.

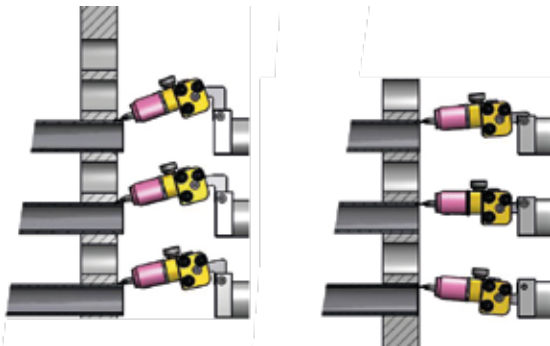
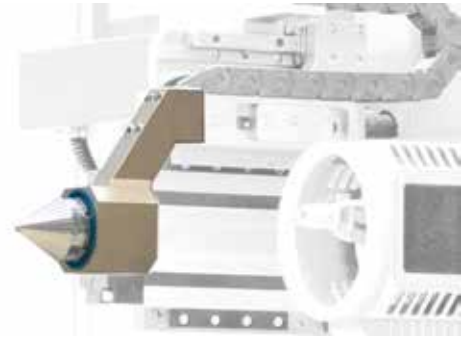

Electrode angle of incidence

Thanks to components with preset angles, the system setting is absolute and repeatable for all welding geometries.

Facilitates geometric set up operations as well as being extremely stable and robust.



MausCAMNET

Conversion software for X-Y programming starting from CAD drawing used for tubesheet holes drilling

DXF from CAD standard

The system is based upon the reading of the DXF drawing interchange format and is able, in a few steps, to process the CAD files of the tube sheet and automatically obtain the matrix of the coordinates of the tubesheet holes.

Interactive processing

During processing it is possible to control and optimise the path according to the position or the geometry. If the tube sheet is larger than the usable stroke, it is possible to divide the program into several successive parts.

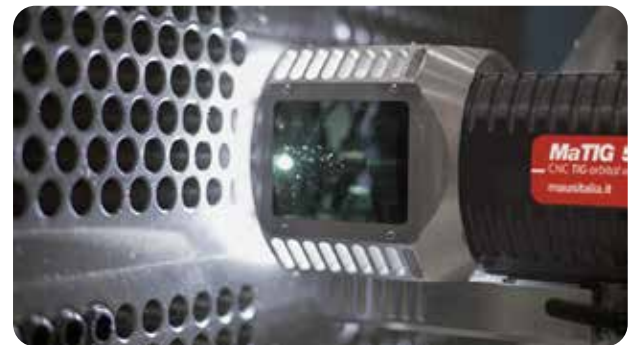

New orbital TIG welding torch

The only product of its kind. The new orbital TIG welding torch has been designed and manufactured in its entirety by Maus Italia. The new electrode clamping system with tangent screws does not require service keys and makes replacing the worn electrode quick (it is no longer necessary to dismantle the ceramic nozzle, the relevant gas diffuser and the filler wire guide).

The wire feed assembly is fully adjustable in all directions. All operations are carried out with a single supplied key.



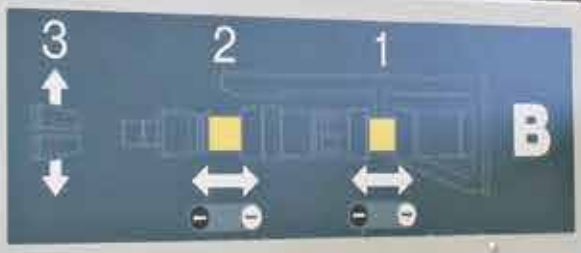
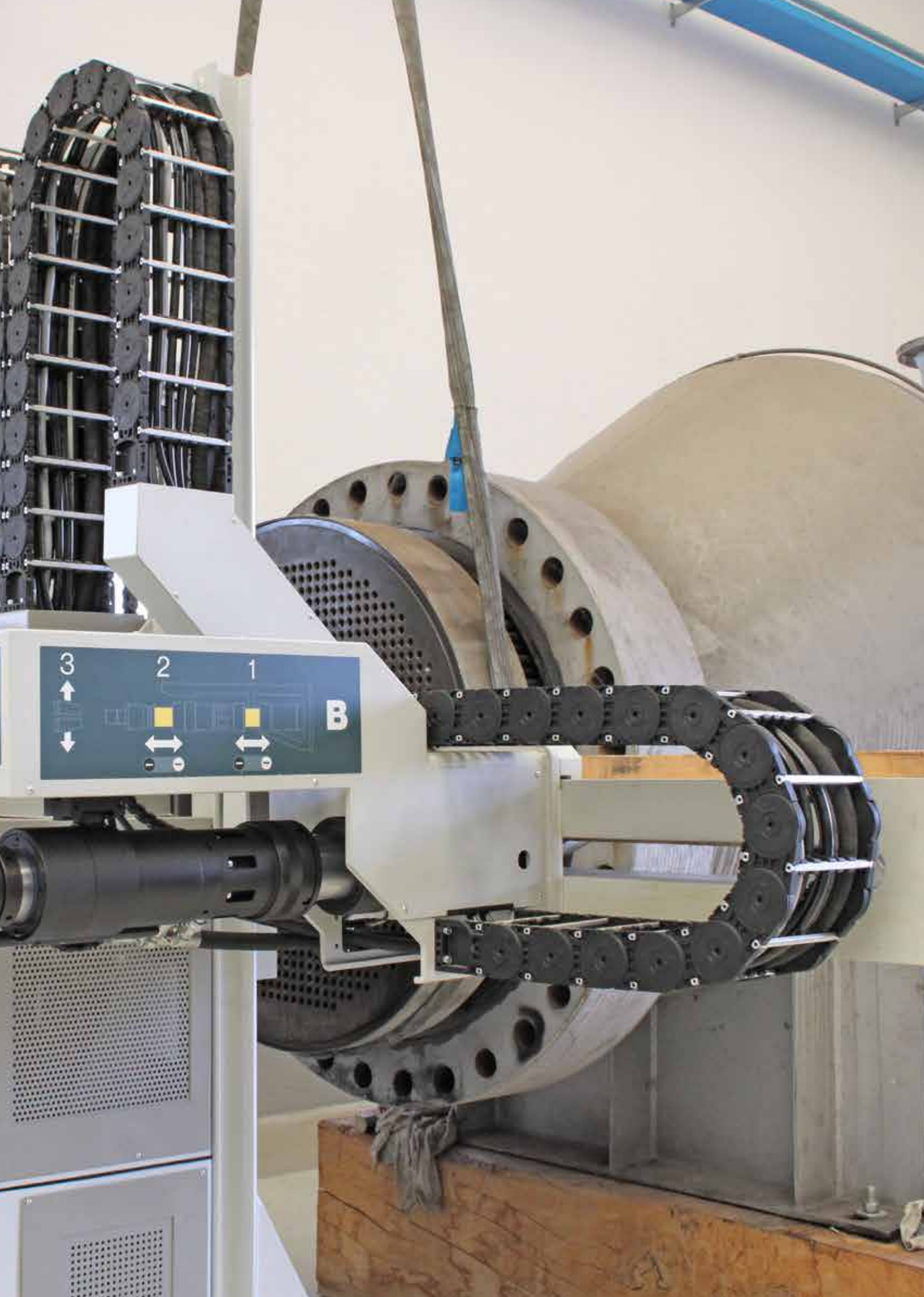

Tube bundle insertion

Special machines for the insertion of tube bundle in the production of heat exchangers

During the final phase in the construction of heat exchangers, the insertion of the new tube bundle inside the shell can compromise the integrity of the almost finished product. With its special BundleIn and MefShopIN machines, Maus Italia offers two original and exclusive solutions that are designed to cover the entire range of requirements.

These products have been designed to meet the growing needs of this operation for the quality, safety and speed.

BundleIN XT60

Automatic hydraulic tube bundle inserter for heat exchangers with patented COS system to compensate for crane oscillations on the Y axis

According to heat exchanger manufacturers, the insertion of long and heavy tube bundles floating inside the shells is one of the most challenging steps of the assembly cycle.

With the BundleIN XT60, Maus Italia offers a piece of equipment that can solve this type of problem quickly, accurately and safely. Once the fixing points of the ropes are attached to the shell, the BundleIN XT60 can insert the tube bundle at a speed of 2m/min (6.5 Ft/min).

The adjustable generated coaxial force up to 60 T (132300 Lb) brings the tube bundle inside the shell smoothly and safely.



High speed



High safety



User friendly

Up to 60 T (132300 Lb)

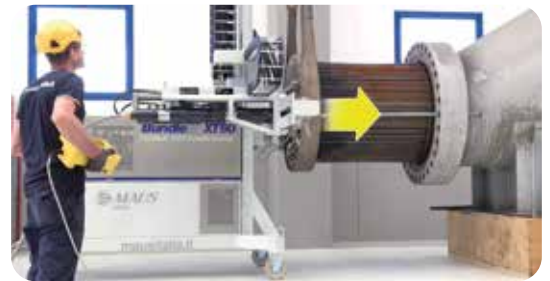



COS

The patented COS system

The patented COS system enables the BundleIN XT60 to carry out a rapid, safe and quality insertion, compensating for inevitable oscillations due to the movement of the crane during the insertion manoeuvre.

With the patented COS system, the loads generated by the oscillations of the tube bundle generated during the crane movement, are absorbed by the BundleIN XT60, safeguarding the integrity of the wheels and enabling easy sliding over the floor.

System with two servo-assisted hydraulic axes, fitted with the COS system to compensate the oscillations from the bridge crane.

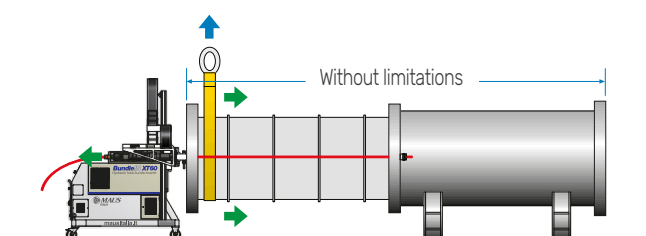
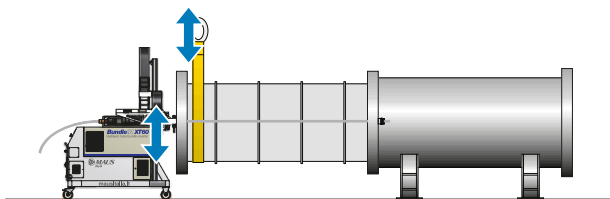
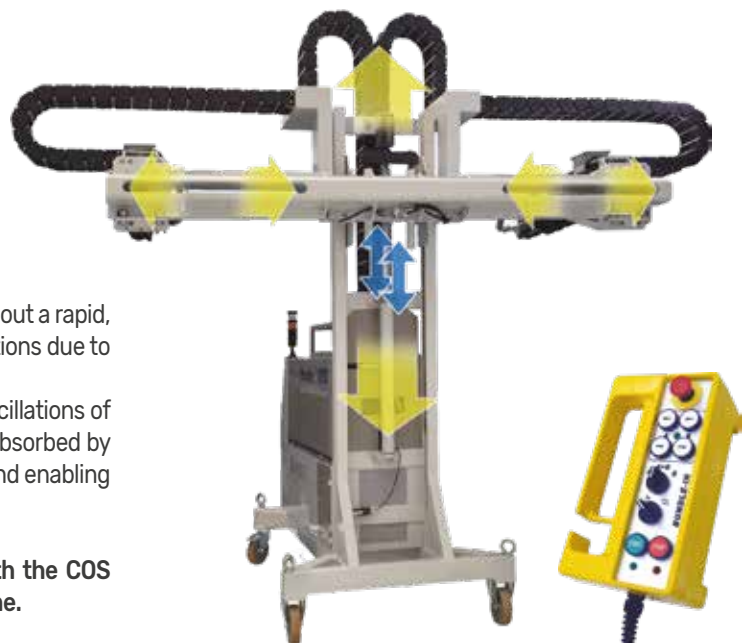

Example of insertion where the machine follows the tube bundle

—
Pulling ropes

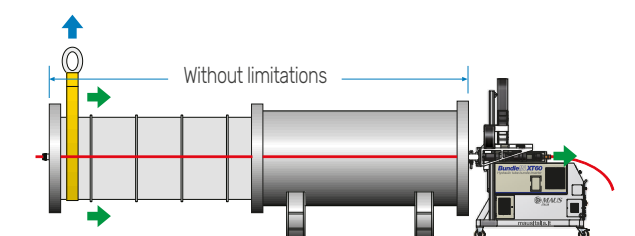

Example of insertion with support to the shell

Mef shopIN

Fixed station tube bundle heat exchangers inserter / extractor

The Mef shopIN is a free-standing machine (no crane required), capable of inserting / extracting the bundle quickly, accurately and safety. Thanks to its experience in the manufacturing of maintenance bundle extractors, Maus Italia offers a machine which is dedicated to modern heat exchanger manufacturers.

Max load capacity 40 T (88185 Lb)

Total safety for both operator and product





Outstanding features

Four hydraulic columns fitted on the fixed frame allow the mobile frame upon which the main hydraulically-powered carriage runs to be raised (the part that ensures the driving force required for insertion and extraction).

The ability for the mobile frame to move laterally and longitudinally ensures a precise and fast alignment of the bundle to the shell.

Power unit

Independent electric hydraulic power unit assembled on a four-wheeled trolley for easy movement.

Remote control

To increase operational safety, the Mef ShopIN is remote-controlled (wireless model also available) which allows the operator to manage the machine's main movements from nearby.







Tube bundle handling

The complete line of Maus Italia equipment for tube bundle extraction, handling and transportation

These machines, designed and manufactured by Maus Italia, are the result of decades of experience with hundreds of clients across five continents.

Mef Express HT

Aerial extractor for heat exchanger tube bundles to ensure minimum downtime and maximum protection of the tube bundle during extraction

Maus Italia presents, for the extraction and insertion of tube bundles in the plant, a complete new range of Mef Express HT aerial tube bundle extractors with dedicated solutions for handling by crane for maintenance at great heights.

Years of evolution of the Mef Express product series have allowed the design to be revisited, making the Mef Express HT (High Technology) aerial tube bundle extractors of today even more lightweight, more flexible and easier to handle.

Starting from the numerous standard products that cover common market requests, Maus Italia is also able to provide customized solutions to solve extreme cases with ATEX / OFF-SHORE versions.

For tube bundles up to 125 T in weight



ATEX Certification on request



DNV
ST-0378 | ST-E273
MARITIME

DNV certification for FPSO and offshore platforms

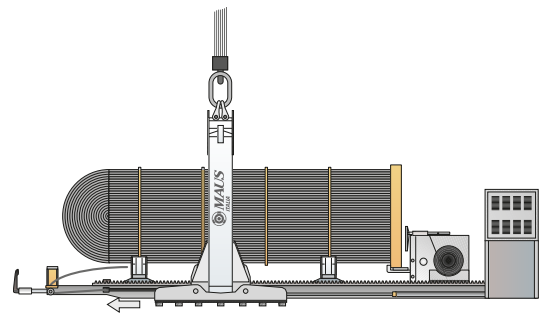



Electrowelded steel ring for lifting the extractor

Maus Italia applies targeted solutions to solve customer problems.
The ring can be: Circular / Oval / Divisible in three parts

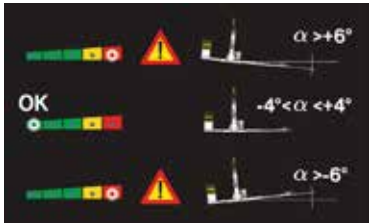
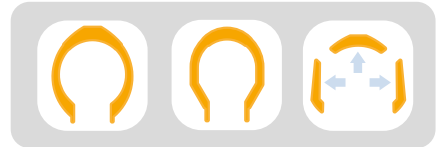

EOC electronic overturning control

Innovative control system which allows overhead handling of loads in complete safety by inhibiting any incorrect commands that could compromise the stability of the Mef express HT.

Mef Express HT NAVY



Maus Italia can, on customer request, manufacture Mef express HT extractors in an offshore version. The DNV MARITIME certified transformation includes everything already done to obtain the ATEX certification with additional specifications for lifting accessories, movement and sizing guided by the certification specifications with a more accurate process control.

DNV certification for FPSO and offshore platforms



DNV
ST-0378 | ST-E273
MARITIME



BundleTutor Lifter

For easy, safe and secure aerial handling of the tube bundle

Maus Italia presents the BundleTutor lifter for the aerial handling of tube bundles, for use both within the plant and during the production of heat exchangers. By lifting the tube bundle easily and safely, the BundleTutor lifter eliminates the risk of destroying the baffles and damaging the tubes.

The Maus Italia team is available to design custom solutions for extreme circumstances and ATEX / NAVY versions for the offshore market.

➤ For production & onshore/offshore maintenance

Protects the tube bundle

Easy to use



ATEX Certification on request



DNV
ST-0378 | ST-E273
MARITIME

DNV certification for FPSO and offshore platforms



Encircling

The symmetrical clamps of the BundleTutor lifter and independent hydraulically controlled by the operator, can be easily adapted to the dimensions of the tube bundle to be lifted by encircling it carefully along its entire length.



Remote control with connection cable

Allows the operator to control all commands at a safe distance from the handling area without the often clutter connecting cable. (anyway supplied: 10m - 32.8ft)



Wireless remote control

A practical remote control allows the operator to control all the commands, while remaining at a safe distance from the handling area.

Structural analysis

During the 3D design phase, each BundleTutor lifter is subjected to structural analysis using the Finite Element Method. Predicting what will happen when the product is used allows for optimised and free design.

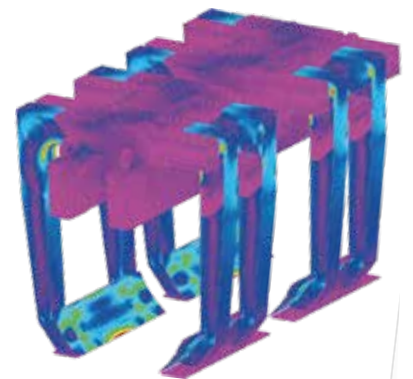
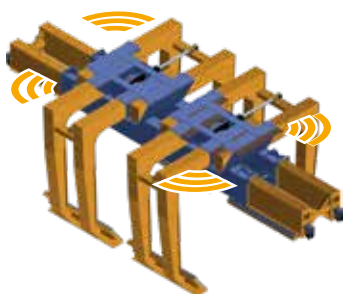

Ultrasonic sensor

The BundleTutor lifter can be equipped with 4 ultrasonic sensors to reliably detect, continuously and accurately, the distance to possible obstacles. A visual signal helps the operator at the crane or overhead crane during handling.



Bundle Tutor Lifter E

For operation in closed spaces while respecting the environment and operator health

Maus Italia offers a fully electric version of the BundleTutor lifter, especially for workshops and closed spaces where the use of a combustion engine causes an unhealthy environment. The BundleTutor Lifter E is offered as a green solution with zero emissions and with autonomy of over 25 working cycles.

BundleTutor Mobil

For the quick, safe and secure independent handling of the tube bundle

Maus Italia offers the BundleTutor mobil for the handling of tube bundles independently of cranes and trucks inside the plant, speeding up loading and unloading of Mef express HT bundle extractors and transportation from the extraction point to the washing area or maintenance workshop. The Maus Italia team is available to design custom solutions to provide solutions for extreme cases and ATEX explosion proof and NAVY versions for the offshore market.

➤ For maintenance

Total protection of the bundle



ATEX Certification on request

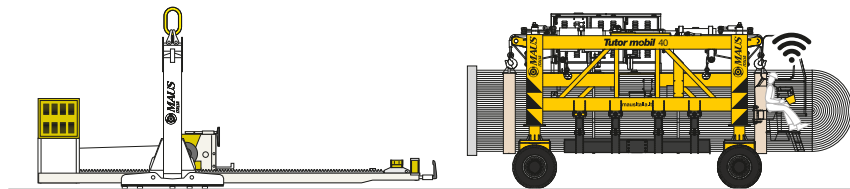

Compensates for errors

The control on the independent ropes, as well as improving the aligned support of the tube bundle, also allows compensation (through rotation) for any potential positioning errors during setting down of the extractor.

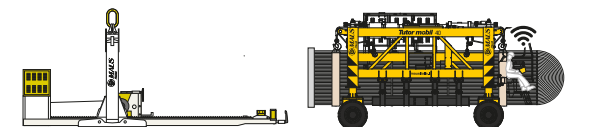
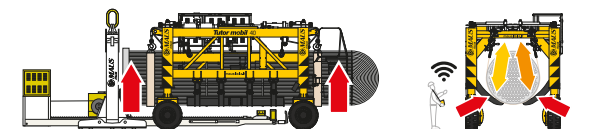
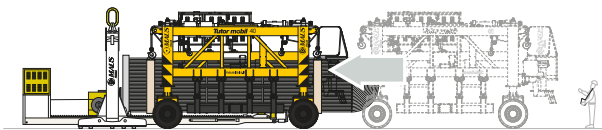
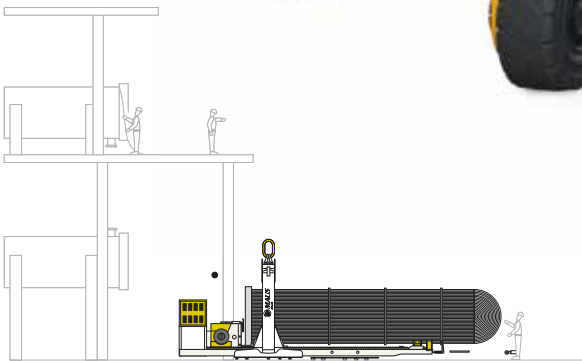

1

Alignment with the extractor and approaching

2

Harnessing of the tube bundle and balancing

3

Lifting and handling of the tube bundle



Mef Mobil

Self-propelled tube bundle puller (on-shore) for the extraction and transportation of tube bundles

The Mef Mobil, self-propelled tube bundle puller, is designed for areas which are difficult to access with cranes for the extraction and transportation of tube bundles.

The Mef Mobil operates autonomously without the need for cranes and trucks for extraction and transportation of the tube bundle to the maintenance area.

Up to 5850 mm (230") Height

Max weight up to 20 Tons.

Solution for difficult access areas



ATEX Certification on request



Special model for low temperature is available on request



Bundle elevation



Longitudinal frame movement



Lateral frame translation



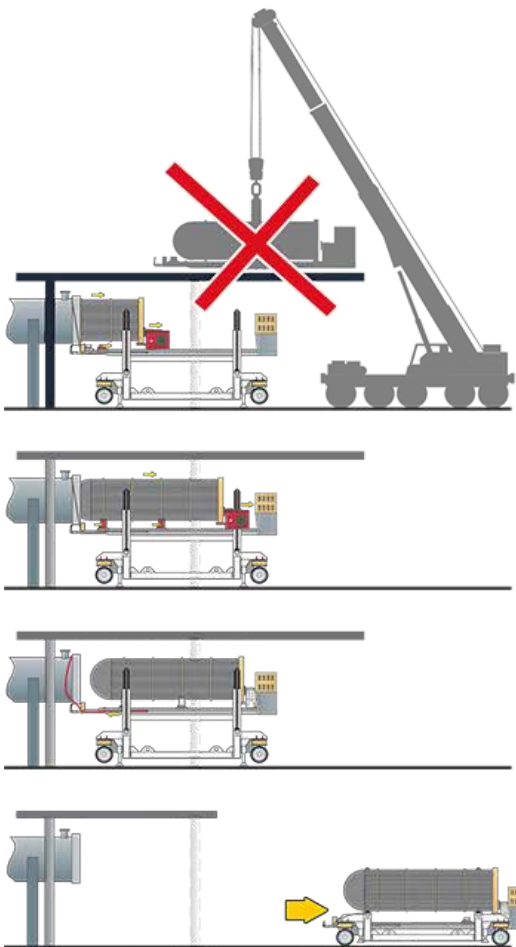

Mef Mobil NAVY



Self-positioning tube bundle puller, remote controlled for extraction, hoisting and movement of tube bundles (off-shore)

Self-positioning tube bundle extractor Mef Mobil NAVY, suitable for ocean platforms and FPSO installations. This is a special model of the Mef Mobil, designed and manufactured to meet the specific demands for safety and off-shore manoeuvrability.

Mef Mobil NAVY is designed to be operated in hazardous areas classified

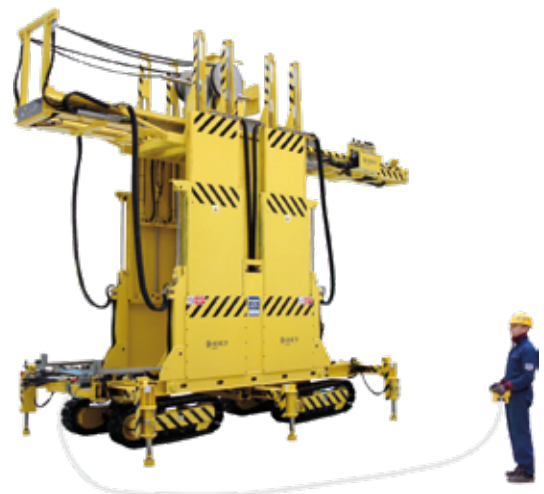
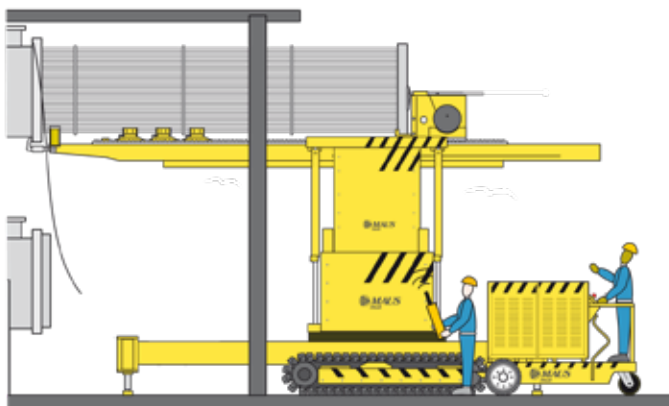

Mef TT 23

Completely independent tube bundle puller for onboard truck assembly

The Mef TT 23 model tube bundle puller is designed to be mounted easily on the truck for the extraction of the tube bundle without the use of a crane. This system is particularly advised for maintenance companies who constantly operate in the petrochemical plant field.

- **Lifting capacity up to 23 Tons**
- **Lifting of the tube bundle**
from 600mm to 7000 mm (from 24" to 275") height
- **Lateral translation of extraction frame +/- 100 mm (+/- 4")**
Hydraulic device for centring the Mef TT 23 in relation to the heat exchanger without the need for repositioning
- **Longitudinal movement of the extraction frame**
to increase the flexibility of the TT 23
- **Bidirectional carriage**
Ability to extract / insert the tube bundle on both sides without turning the truck
- **Slewing ring**
for rotating the whole lifting device (rotation stroke up to 100°)

Up to 7000mm (275") height

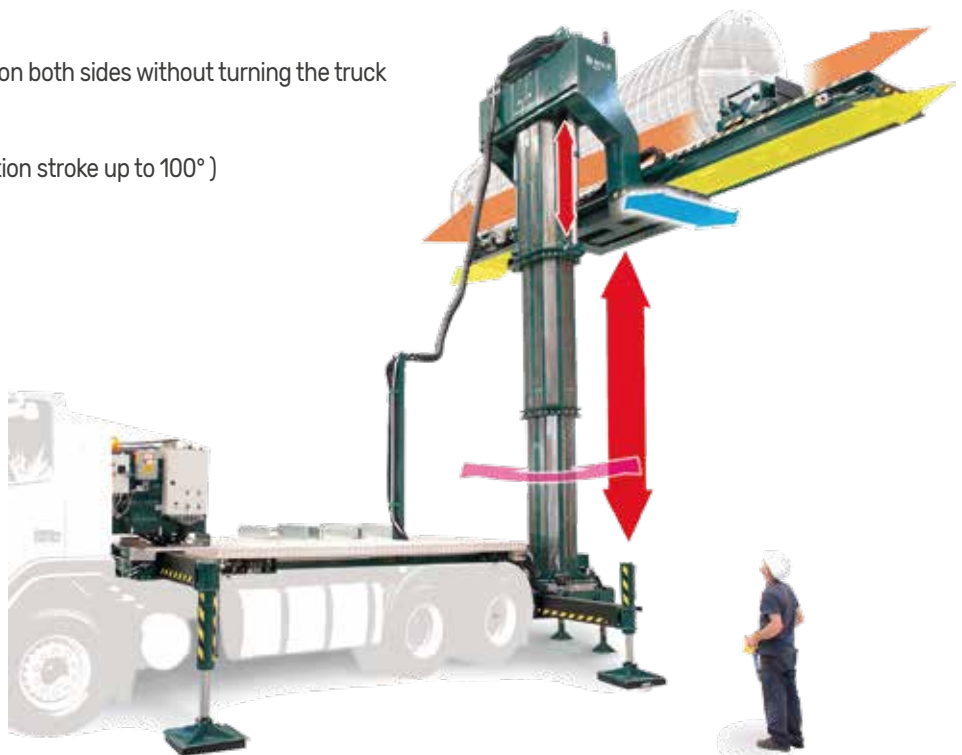

EOC Anti-roll electronic control

The Mef TT 23 has an innovative system which allows loads to be moved in complete safety by inhibiting any incorrect commands that would compromise safety, ensuring compliance with requirements for CE certification.

Assembly

The Maus Italia Mef TT 23 tube bundle puller, in order to easily conform with the standards of the countries in which it has to be used, it can be assembled by a local specialist company on a three-axle truck supplied by the customer as long as it is compatible with the design data.

Mef Fixed NAVY



DNV
ST-0378 | ST-E273
MARITIME



Fixed tube bundle puller, remote controlled for extraction of tube bundles (off-shore)

The Mef fixed NAVY is a simplified stationary model of the Mef mobil to meet the demands of tube bundle extraction on board oil rigs, oceanic petroleum plants and plants on board FPSO vessels.

Mef fixed NAVY fixed tube bundle extractor, suitable for ocean platforms and FPSO installations. This is a simplified version of the Mef mobil NAVY designed and manufactured to meet the specific demands for safety and off-shore manoeuvrability.

- **Mef fixed NAVY is designed to be operated in hazardous areas classified**
- **Mef fixed NAVY 1500156-E CSA model classified area Class 1 - Zone 1 - IIBT3**

Customized



ATEX Certification



Separate motor and control unit

In order to reduce the dimensions and weight of the Mef fixed NAVY, the engine and the hydraulic unit are assembled in a separate unit.



HDS Hardscal

Mechanical internal cleaning with rigid shafts for heat exchanger tubes

The pneumatic cleaners with modular rigid shafts and water cooling of the tool, are the simplest and most effective solution for cleaning double sheet heat exchanger tubes, even if they are completely obstructed. By selecting the appropriate model of cleaning tool according to the characteristics of the residue inside the tubes, we guarantee a deep clean.

The continuous flow of running water through the drainage holes in the tools, with a maximum pressure of 20 Bars (290 psi), provides cooling during operation as well as providing drainage of the removed material.

Handy

Simple to use

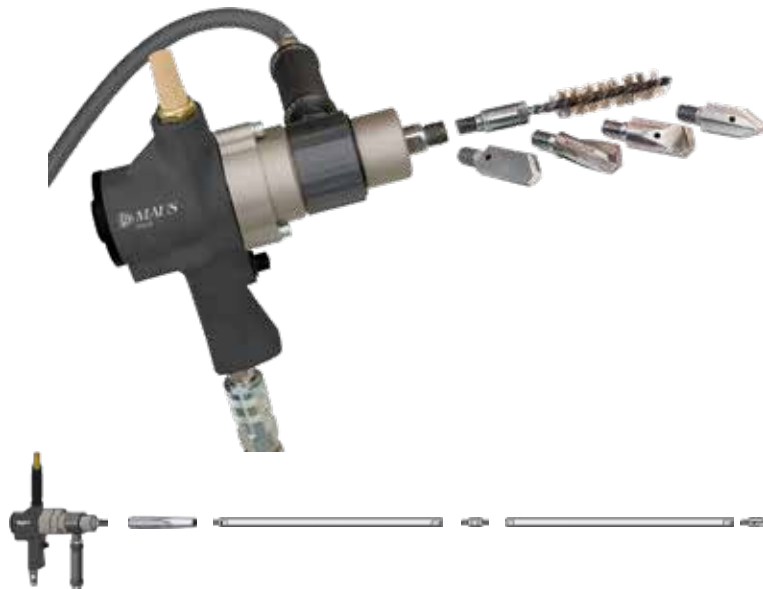

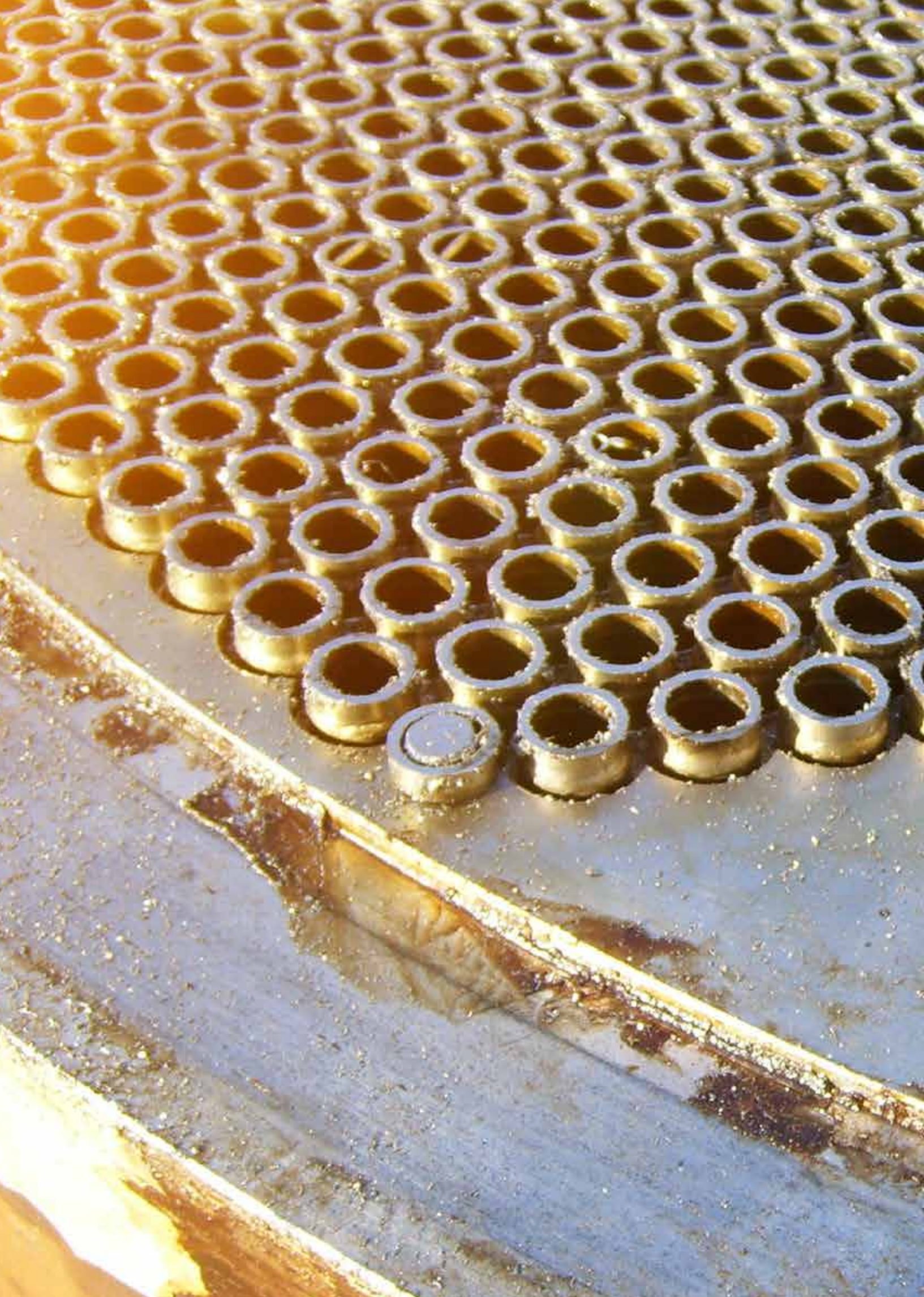



Tube & tube bundle cutting

Products for cutting tubes and tube bundles

During maintenance, partial or total retubing of the tube bundle may be necessary. During this process, one of the main operations is the cutting of individual tubes or of the entire tube bundle.

BundleCut Evolution

Band saw for the dismantling of tube bundle and recovery of heat exchanger tubesheets
Allows rapid and clean separation of the tubesheet from the rest of the bundle

For when it becomes impossible to partially retubing the tube bundle from a heat exchanger, Maus Italia proposes the BundleCut band saws for the rapid, safe and ecological retrieval of the tubesheet.

BundleCut has become "Evolution". Years of product evolution have allowed a complete review of the design, enabling Maus Italia's band saws to be even safer, better performing, more precise and state-of-the-art.

Thanks to the high level of cleanness in the cut, in combination with the Grippul series quick-fastening tube stub extractor and Onlypul and Runpul continuous tube extractors, the BundleCut facilitates and speeds up the recovery of the tubesheet without damaging its holes.

Used for over 20 years in workshops across the globe

Precise and clean cut

High safety



Ø max. tubesheet

BundleCut 2000 Evolution
78" (2000 mm)

BundleCut 3000 Evolution
118" (3000 mm)





 Metal enclosure with barrier

Smart cutting

The ability to continuously control the speed of descent of the cutting arc allows maximum speed without compromising the life of the blade.



Bundle locking

In place of anchoring straps with ratcheting tensioner, Maus Italia proposes a device for the rapid locking of the tube plate. It comprises a vertical hydraulic press, controlled from the console, which, mounted on the base, enables the loading of the tube bundle and the unloading of the separated tube sheet to be accelerated.

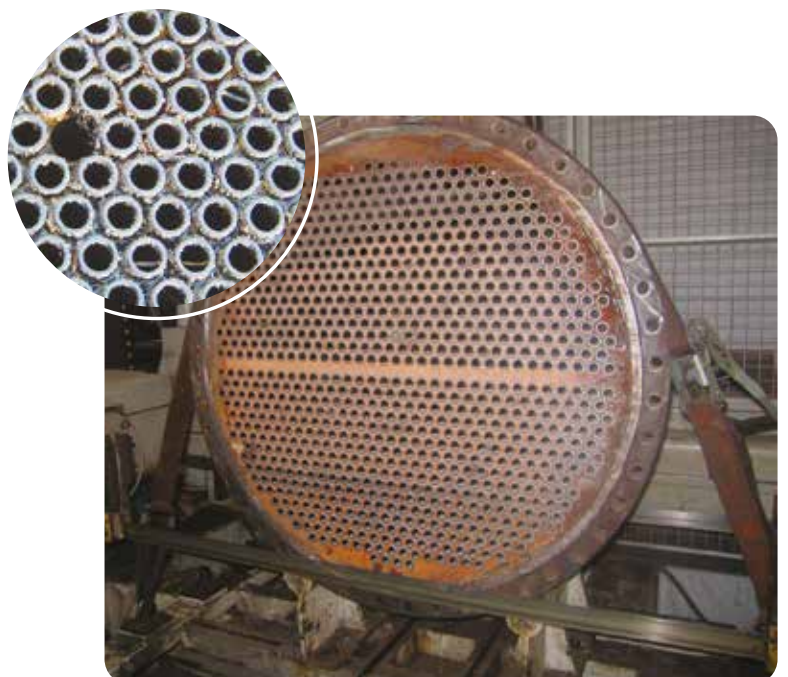

KattexCut

**Hydraulically-operated tube cutter (before Grippul) for heat-exchanger and boilers.
Ensures the rapid recovery of the tubesheet by facilitating tube extraction**

Maus Italia has solved the problem of tubesheet safeguarding and recovery during the dismantling of heat exchangers. The KattexCut, a patented Maus Italia product, instantly cuts the tubes from the tube bundle from the inside, without the production of swarf, thus facilitating subsequent operations, such as:

- the extraction of the tube pieces with Grippul series extractors
- the extraction of the tubes with Runpul series continuous extractors

Instant cuts the tubes from the tube bundle from the inside

Work without metallic residues

Swarf free cutting

Instant

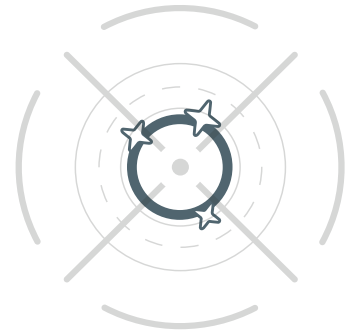

- Using hydraulic drive the KattexCut device gives the tools a radial expansion by incising the tube thickness creating the breaking point, ensuring high productivity

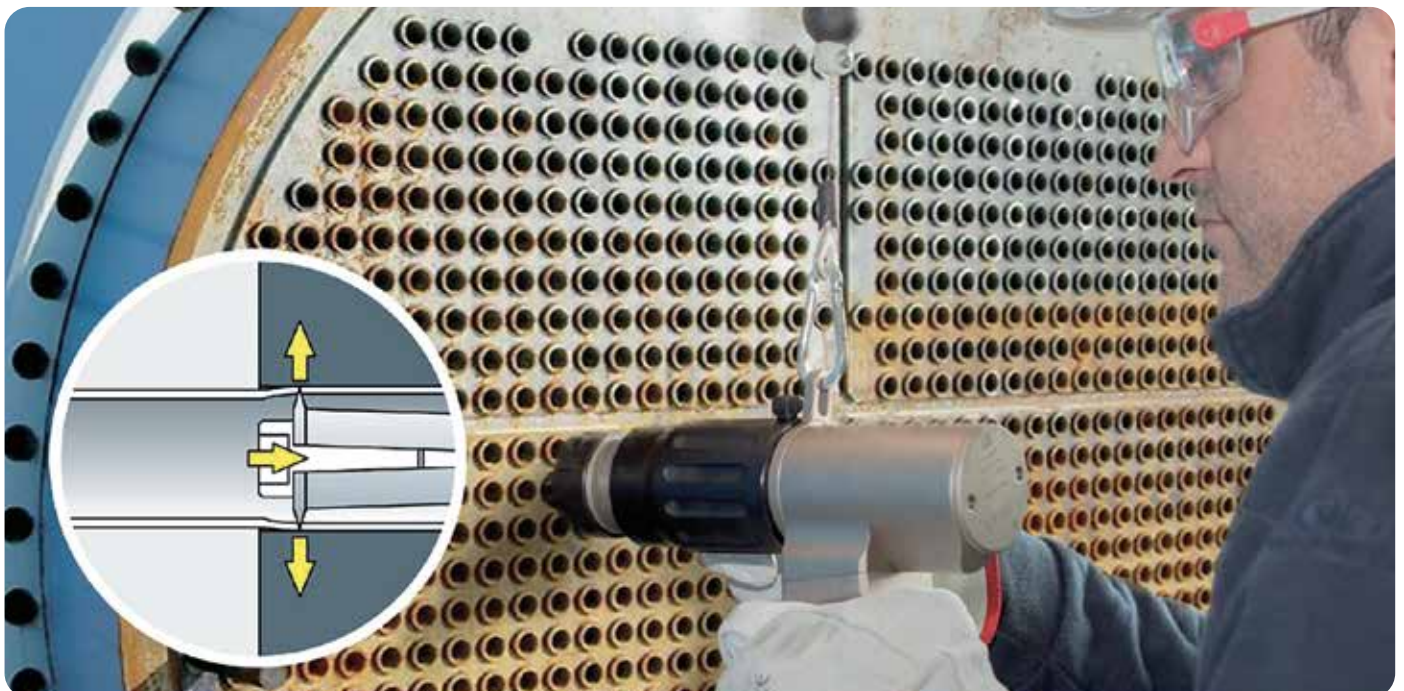



KattexCut 12

- Instant hydraulic internal incisor for tube with OD from 1" (25,40 mm) up to 4" (101,60 mm)

KattexCut 6

- Instant hydraulic internal incisor for tube with OD from 1/2" (12,70 mm) up to 1.1/2" (38,10 mm)



TP2E

Electric hydraulic power unit

TP2P

Pneumatic hydraulic power unit

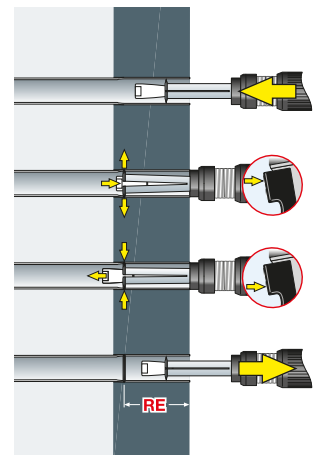

F/794

Motor operated tube cutter for medium tube-sheets

This tube cutter is designed for the use in aintenance of heat exchangers and boilers. Dedicated to the maintenance of exchangers with medium thickness tube sheets.



REmin 2" (50,8 mm) ▶ **REmax** 6" (152,4 mm)



▶ **MBOS 16-2** **MOF**

Portable electric and pneumatic motorizations

F/794/L

Motor operated tube cutter for thick tube-sheets

This tube cutter is designed for the use in aintenance of heat exchangers and boilers. Dedicated to the maintenance of exchangers with very thick tube sheets.



REmin 4" (101,6 mm) ▶ **REmax** 12" (304,8 mm)









Stub & tube extraction

During maintenance it may be necessary to carry out partial or total retubing of the tube bundle

Here you can find the machines and tools entirely designed and manufactured by Maus Italia for pulling stubs and tubes for tube bundle maintenance.

Grippul

Quick gripping and extracting hydraulic stub puller

The quick gripping stub pullers of the Grippul line are the result of more than forty years of experience in tube extraction gathered by Maus Italia. Grippul was designed and manufactured for quick extraction of stubs from tube sheets.

Grippul, electrically or pneumatically operated versions, is equipped with remote control and it is available in two models depending on the extraction force (Grippul 11 and Grippul 21).

In combination with BundleCut or Kattex, it facilitates and speeds up the recovery of tube sheets.

Quick

Inexpensive

High quality

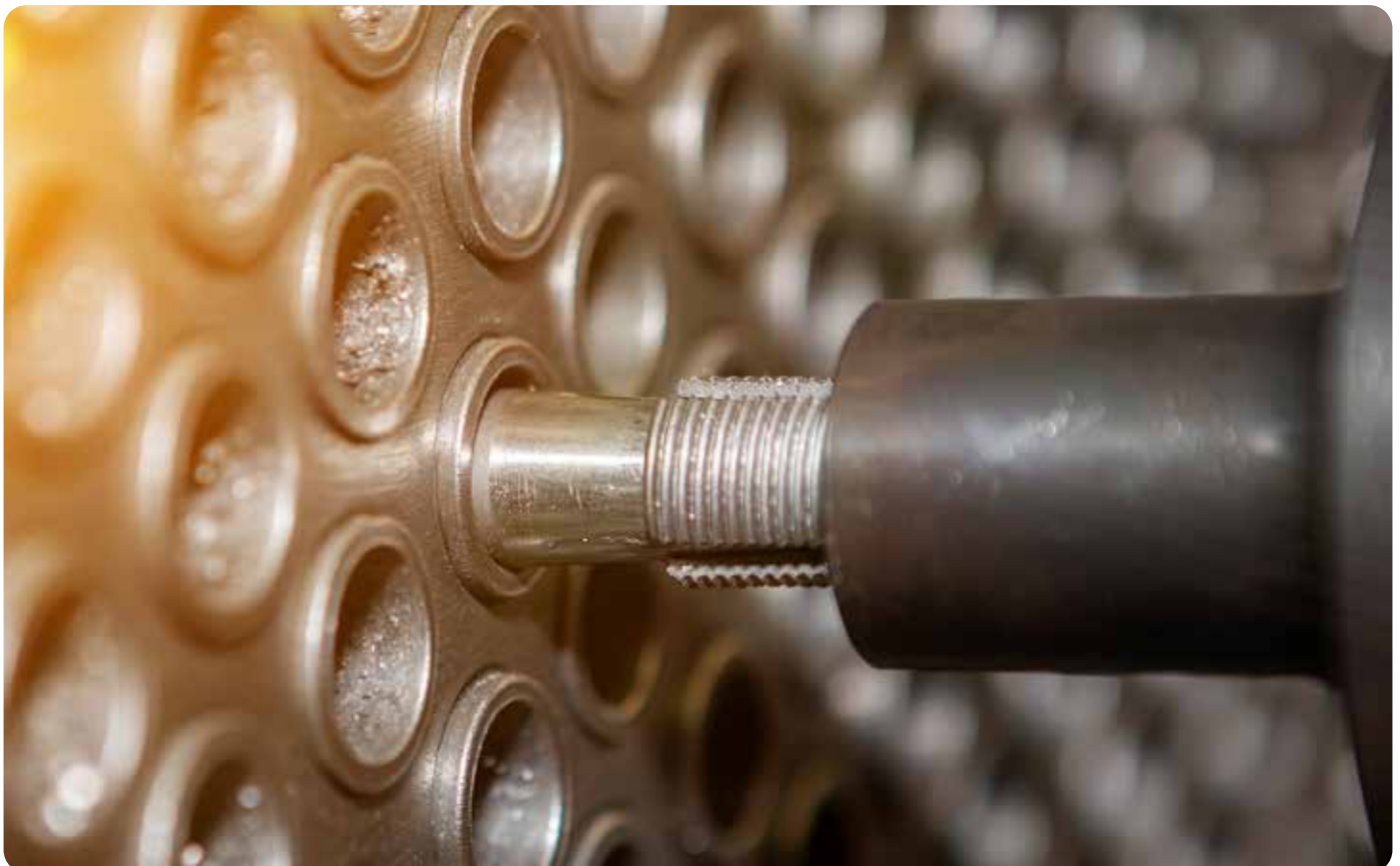



TP10 EVV

Electric hydraulic power unit

TP10 PVV

Pneumatic hydraulic power unit



ABTS

The Anti-Breaking Tie-Rod System allows the force with which the jaw penetrates the tube to be regulated to suit the tube's diameter and the material of which it is made. This device means the system is unaffected by the difference in inside diameter of, as much as 1 mm (0.04"), between tubes in the same sheet, preventing tie-rod breakage.



OPS

The electric Over-Pressure Switch cuts off hydraulic fluid delivery when the piston reaches the end of its stroke, preventing unnecessary overpressure in the system.



RC24

The RC24 remote control beside the knobs simplifies and speeds up stub extraction. In the electric version it is powered at low voltage 24 Volts.



RSR

The Revolving Support Ring on which the Grippul is suspended during use allows optimal positioning in the tightest spaces.

Runpul

Automatic hydraulic tube pulling for continuous high speed extraction of tubes suitable for large scale maintenance work

Maus Italia automatic hydraulic tube pullers are the result of more than forty years of experience in the field of tube extraction. Runpul is designed and manufactured for fast and continuous extraction. Runpul comes in an electrically or pneumatically operated version. It is equipped with an incorporated remote control and comes in four versions depending on the extraction force (Runpul 15, Runpul 30, Runpul 45 and Runpul 60).

Automatic

High speed

High quality

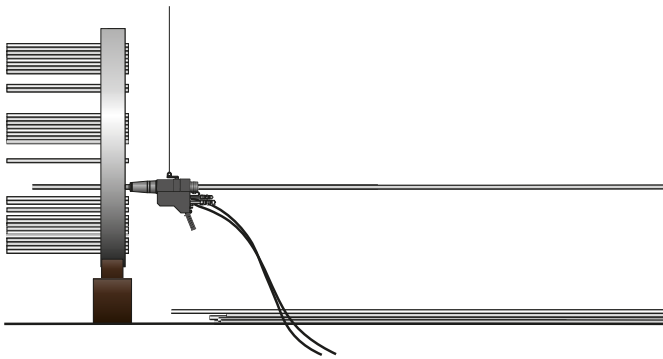

4 Different versions:

Runpul 15

➤ from 3/8" to 1.1/8" (9,52 to 28,58 mm)

Runpul 30

➤ from 3/8" to 1.1/4" GAS (9,52 to 42,40 mm)

Runpul 45

➤ from 1" to 3" (25,40 to 76,20 mm)

Runpul 60

➤ from 2" to 4" (50,80 to 101,60 mm)

TP60HDE

Electric hydraulic power unit

TP60HDP

Pneumatic hydraulic power unit



The Unclamping System Device is an emergency system for unlocking jaws that are stuck on the tube in case the Runpul needs to be removed from the tube.



The Over-Pressure Switch cuts off hydraulic oil delivery when the piston reaches the end of its stroke, preventing unnecessary overpressure in the system.

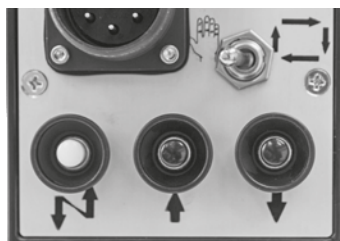

The RC24 remote control beside the knobs simplifies the working steps. In the electric version it is powered at a low voltage of 24 Volts. In its pneumatic version, the control is operated by the air pressure.

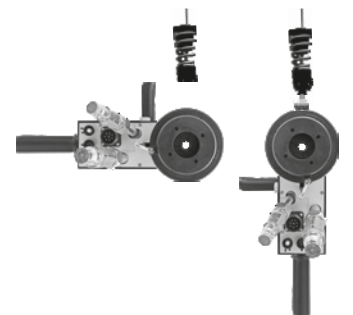

The Revolving Support Ring on which the Runpul is suspended during use allows optimal positioning in the tightest spaces.

Onlypul

Semi-automated hydraulic tube puller for small-scale maintenance

Maus Italia semi-automated hydraulic tube pullers are the result of more than forty years of experience in the field of tube extraction. Onlypul is designed and built for semi-automated and continuous tube extraction. It comes in four versions depending on the extraction force (Onlypul 15, Onlypul 30, Onlypul 45 and Onlypul 60)

Semi-automatic

Entry level

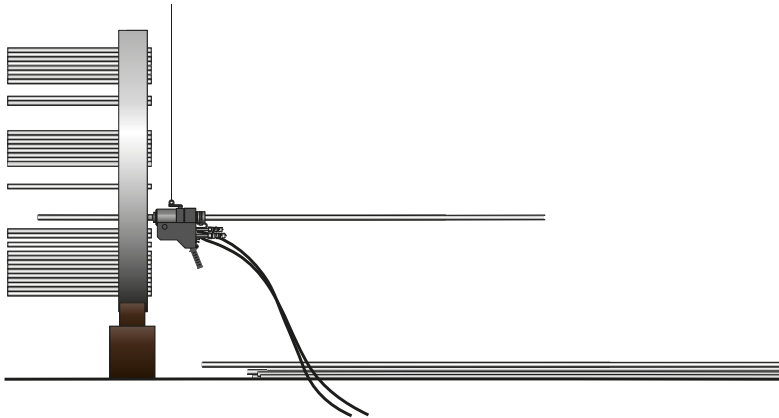

4 Different versions:

Onlypul 15

- from 3/8" to 1.1/8" (9,52 to 28,58 mm)

Onlypul 30

- from 3/8" to 1.1/2" GAS (9,52 to 38,10 mm)

Onlypul 45

- from 1" to 3" (25,40 to 76,20 mm)

Onlypul 60

- from 2" to 4" (50,80 to 101,60 mm)

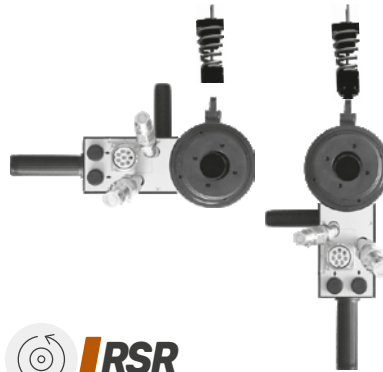

The Revolving Support Ring on which the Onlypul is suspended during use allows optimal positioning in the tightest spaces.



The RC24 remote control beside the knobs simplifies the working steps. In the electric version it is powered at a low voltage of 24 Volts.



Equipment

- > Transport case
- > Onlypul hydraulic puller
- > N°2 hydraulic hoses (length: 6m)
- > Set of spares gaskets
- > Set of series keys
- > Instruction manual



TP10 EVV

Electric hydraulic power unit

TP10 PVV

Pneumatic hydraulic power unit

Manual tools

Equipment for the manual maintenance of the tubes in the heat exchangers

This panorama of manual tools is the entire products of Maus Italia for the manual, low cost maintenance of tubes in heat exchangers in oil refineries, condensers in electric power stations, boilers, etc...

These Manual tools work in synergy to increase the effectiveness of the work on the tube being replaced. The tube reamer F/791 starts first by reducing the thickness of the tube to enable the F/793 to enter the part that has been reamed (therefore offering less resistance) and to expel the tube. The tube collapsing tool F/792 is used when the thickness of the tube is not high and offer less resistance.

Manual tools also includes manual tube cutters F/790, a manual extractors F/800 and a pneumatic hammer F/789 suggested for use with the above tools.

Flexibility and economy of use

High quality of maintenance

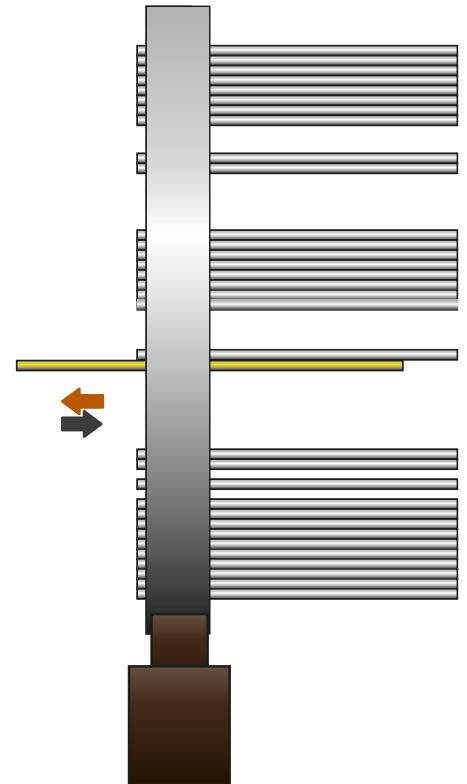

F/790



One revolution tube cutter

Cheaper tube cutter, adjustable reach from 50,8 mm (2") to 152,4 mm (6").
The F/790 was designed for hand use with a tap wrench and its functioning is based on the eccentricity of the blade.

F/791



Tube reamer

These are high-speed steel reamers, with Morse taper connection and rear tang with diameter ground in accordance with the BWG of the tubes. To use to reduce the thickness of tubes to be replaced, for a depth of about 80% of the thickness of the sheet.

F/793



Tube expeller

Use preferably with a pneumatic hammer. Standard tang: $\varnothing 17,2 \text{ mm (} 0.677" \text{)} \times 60,3 \text{ mm (} 2.3/8" \text{)}$

F/792



Tube collapsing tool

Used for crumpling tubes of non-ferrous alloys or ferrous alloys made lighter with the use of the reamer F/791 and expelling them from the tube plate. To be used preferably with a pneumatic hammer. Standard tang: $\varnothing 17,2 \text{ mm (} 0.677" \text{)} \times 60,3 \text{ mm (} 2.3/8" \text{)}$

F/800



Manual extractor

Recommended for small maintenance jobs, the F/800 hand extractor allows easy removal of stubs and tubes.



Maus Italia S.p.A.

SP 415 KM 30 (nuova strada di arrocco)
26010 Bagnolo Cremasco (CR) Italy
PIVA: 00141010199

Telefono: +39 0373 2370

expo@mausitalia.it
www.mausitalia.it

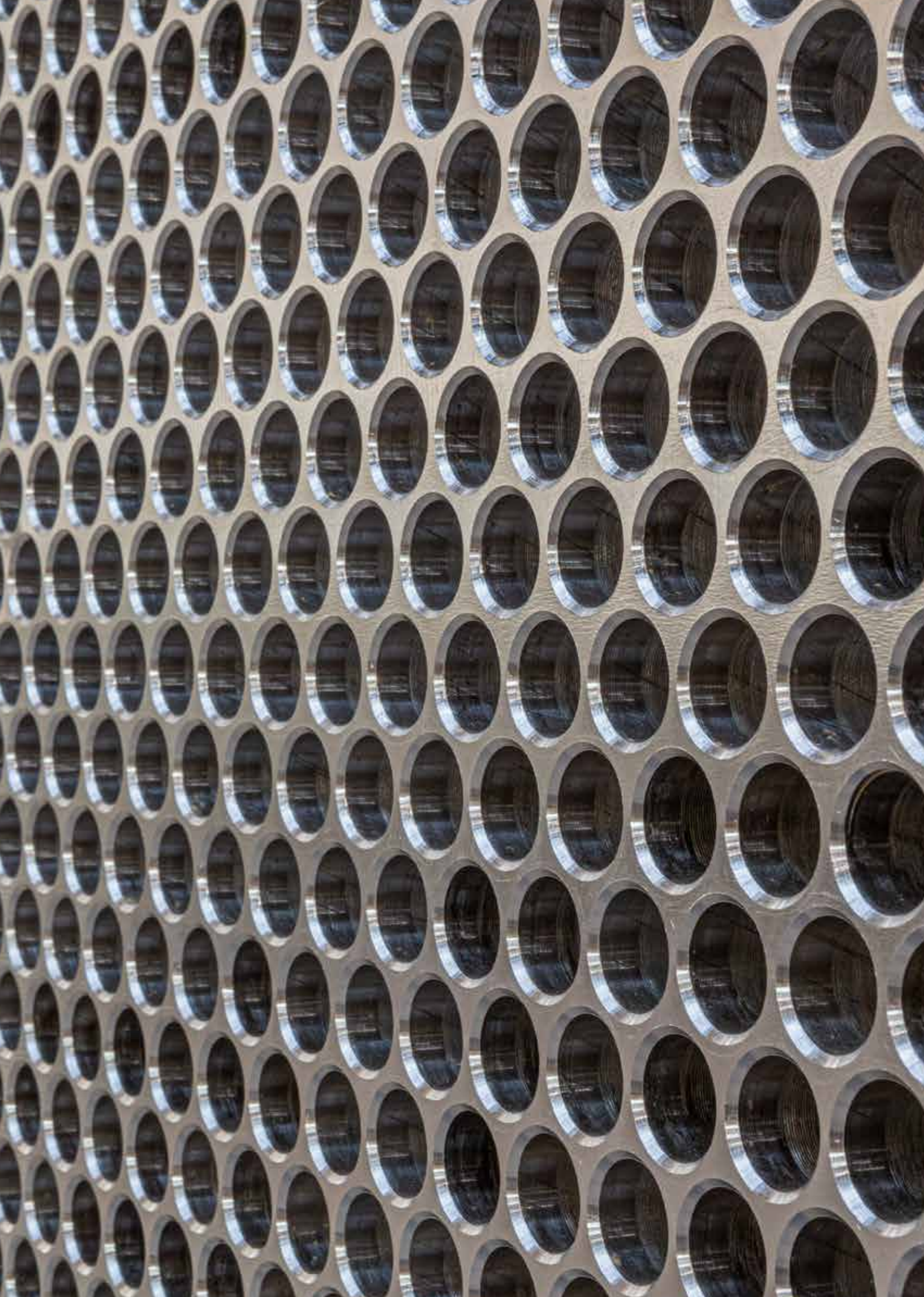



mausitalia.it

